



Main

Range of product	Zelio Control
Product or component type	Industrial measurement and control relays
Relay type	Control relay
Product specific application	For 3-phase supply
Relay name	RM4-T
Relay monitored parameters	Asymmetry Phase failure detection Phase sequence
Time delay	Fixed 0.5 s
Measurement range	160...300 V
Contacts type and composition	1 C/O
Poles description	3P

Complementary

Output contacts	1 C/O
Setting accuracy of the switching threshold	+/-3 %
Switching threshold drift	<= 0.5 % within the measuring range <= 0.06 % per degree centigrade depending permissible ambient air temperature
Setting accuracy of time delay	10 P
Time delay drift	<= 0.5 % within the measuring range <= 0.07 % per degree centigrade depending on the rated operational temperature
Hysteresis	50 % fixed of asymmetry percentage
Delay at power up	< 650 ms
Measuring cycle	<= 80 ms
Adjustment of asymmetry threshold	5...15 %
Marking	CE
Overvoltage category	III conforming to IEC 60664-1
[Ui] rated insulation voltage	500 V conforming to IEC
Supply frequency	50/60 Hz +/- 5 %
Operating position	Any position without
Connections - terminals	Screw terminals 2 x 2.5 mm ² , flexible cable without cable end Screw terminals 2 x 1.5 mm ² , flexible cable with cable end
Tightening torque	0.6...1.1 N.m
Mechanical durability	<= 30000000 cycles
[I _{th}] conventional free air thermal current	8 A
[I _e] rated operational current	0.3 A at 70 °C 115 V DC-13 conforming to VDE 0660 0.3 A at 70 °C 115 V DC-13 conforming to IEC 60947-5-1/1991 0.1 A at 70 °C 250 V DC-13 conforming to VDE 0660 0.1 A at 70 °C 250 V DC-13 conforming to IEC 60947-5-1/1991 3 A at 70 °C 250 V AC-15 conforming to VDE 0660 3 A at 70 °C 250 V AC-15 conforming to IEC 60947-5-1/1991 3 A at 70 °C 24 V AC-15 conforming to VDE 0660 3 A at 70 °C 24 V AC-15 conforming to IEC 60947-5-1/1991 3 A at 70 °C 115 V AC-15 conforming to VDE 0660 3 A at 70 °C 115 V AC-15 conforming to IEC 60947-5-1/1991 2 A at 70 °C 24 V DC-13 conforming to VDE 0660 2 A at 70 °C 24 V DC-13 conforming to IEC 60947-5-1/1991
Switching capacity in mA	10 mA at 12 V
Switching voltage	250 V AC <= 440 V AC

The information provided in this documentation contains general descriptions and/or technical characteristics of the performance of the products contained herein. This documentation is not intended as a substitute for and is not to be used for determining suitability or reliability of these products for specific user applications. It is the duty of any such user or integrator to perform the appropriate and complete risk analysis, evaluation and testing of the products with respect to the relevant specific application or use thereof. Neither Schneider Electric Industries SAS nor any of its affiliates or subsidiaries shall be responsible or liable for misuse of the information contained herein.

Contacts material	90/10 silver nickel contacts
Number of cables	2
Height	78 mm
Width	22.5 mm
Depth	80 mm
Terminals description ISO n°1	(15-16-18)OC (L1-L2-L3)CO
Output relay state	Tripped, fault present
9 mm pitches	2.5
Product weight	0.11 kg
Time delay on de-energisation	0.5 s

Environment

Standards	EN/IEC 60255-6
Product certifications	CSA GL UL
Directives	89/336/EEC - electromagnetic compatibility 73/23/EEC - low voltage directive
Ambient air temperature for storage	-40...85 °C
Ambient air temperature for operation	-20...65 °C
Relative humidity	15...85 % 3K3 conforming to IEC 60721-3-3
Vibration resistance	0.35 ms (f = 10...55 Hz) conforming to IEC 60068-2-6
Shock resistance	15 gn for 11 ms conforming to IEC 60068-2-27
IP degree of protection	IP50 (casing) conforming to IEC 60529 IP20 (terminals) conforming to IEC 60529
Pollution degree	3 conforming to IEC 60664-1
Dielectric test voltage	2.5 kV
Non-dissipating shock wave	4.8 kV
Resistance to electrostatic discharge	8 kV air conforming to IEC 61000-4-2 level 3 6 kV contact conforming to IEC 61000-4-2 level 3
Resistance to electromagnetic fields	10 V/m conforming to IEC 61000-4-3 level 3
Resistance to fast transients	2 kV conforming to IEC 61000-4-4 level 3
Disturbance radiated/conducted	CISPR 11 group 1 - class A CISPR 22 - class A

3-phase Supply Control Relays

Dimensions

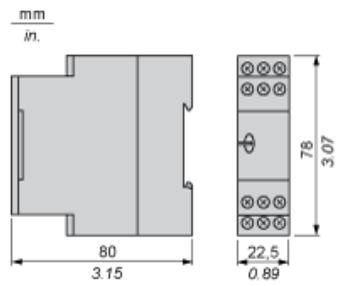

3-phase Supply Control Relays

Rail mounting

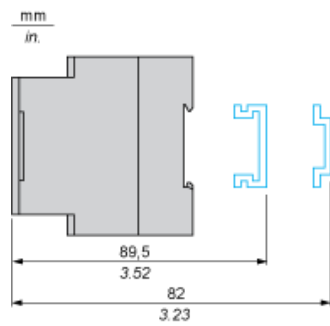

Screw fixing

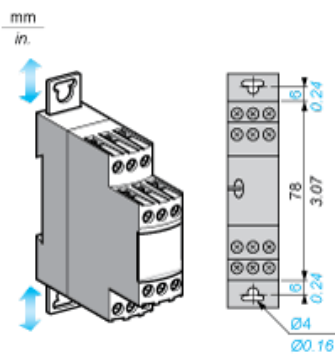

3-Phase Supply Control Relays

Wiring Diagram

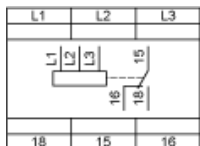

L1, Supply to be monitored
L2,
L3
15-18, 1st C/O contact of the output relay
15-16

Application Scheme

Example

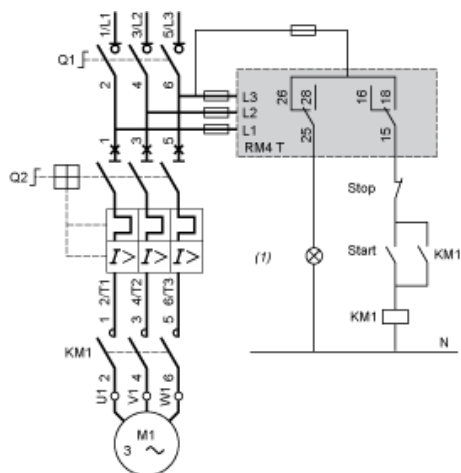

(1) Fault

Electrical Durability and Load Limit Curves

AC Load

Curve 1: Electrical durability of contacts on resistive load in millions of operating cycles

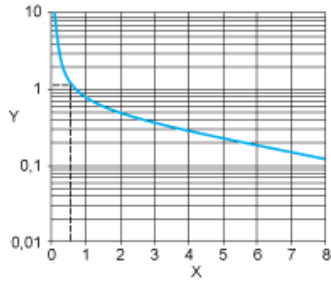

X Current broken in A
Y Millions of operating cycles

Curve 2: Reduction factor k for inductive loads (applies to values taken from durability Curve 1)

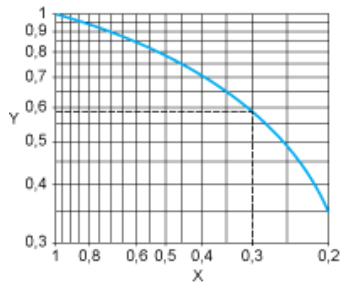

X Power factor on breaking (cos φ)
Y Reduction factor K

DC Load

Load limit curve

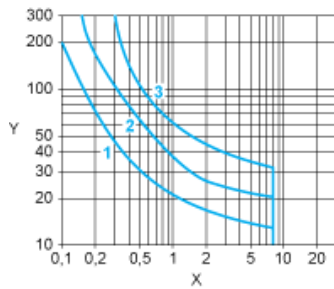

X Current in A
Y Voltage in V
1 L/R = 20 ms
2 L/R with load protection diode
3 Resistive load

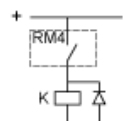

Function Diagram

Detection of Phase Asymmetry

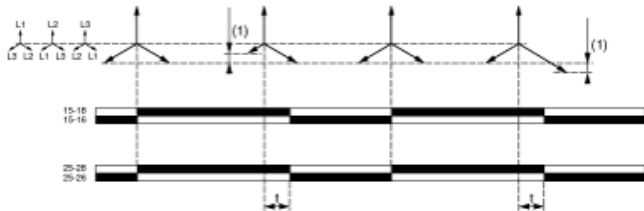

Legend

t Time delay

(1) Asymmetry > set threshold

15/18, 15/16; 25/28, 25/26 Output relays connections

Relay status: black color = energized.