



Main

Range of product	Harmony K
Product or component type	Complete cam switch
Component name	K115
[I _{th}] conventional free air thermal current	115 A
Product mounting	Front mounting
Fixing mode	4 holes
Cam switch head type	With front plate 88 x 88 mm
Type of operator	Black handle
Rotary handle padlocking	Without
Presentation of legend	With metallic legend, 0 - 1 black marking
Cam switch function	Switch
Return	Without
Off position	With Off position
Poles description	4P
Switching positions	Right: 0° - 60°
IP degree of protection	IP40 conforming to NF C 20-010 IP40 conforming to IEC 529

Complementary

Switching angle	60 °
[U _i] rated insulation voltage	690 V degree of pollution 3 conforming to IEC 60947-1 690 V degree of pollution 3 conforming to EN 60947-1
Rated operational power in W	7500 W AC-3 / 220/240 V 1 phase conforming to EN/IEC 60947-3 65000 W AC-23A / 660/690 V 3 phases conforming to EN/IEC 60947-3 5500 W AC-23A / 110 V 1 phase conforming to EN/IEC 60947-3 45000 W AC-23A / 380/440 V 3 phases conforming to EN/IEC 60947-3 3700 W AC-3 / 110 V 1 phase conforming to EN/IEC 60947-3 30000 W AC-3 / 660/690 V 3 phases conforming to EN/IEC 60947-3 30000 W AC-3 / 380/440 V 3 phases conforming to EN/IEC 60947-3 30000 W AC-23A / 220/240 V 3 phases conforming to EN/IEC 60947-3 22000 W AC-23A / 380/440 V 1 phase conforming to EN/IEC 60947-3 15000 W AC-3 / 220/240 V 3 phases conforming to EN/IEC 60947-3 15000 W AC-23A / 220/240 V 1 phase conforming to EN/IEC 60947-3 13000 W AC-3 / 380/440 V 1 phase conforming to EN/IEC 60947-3
[I _e] rated operational current AC	100 A AC-21A conforming to EN/IEC 60947-3
Short-circuit current	15000 A
Short circuit protection	125 A by cartridge fuse, type gG
[U _{imp}] rated impulse withstand voltage	6 kV conforming to IEC 947-1 6 kV conforming to EN 947-1
Contacts operation	Slow-break
Positive opening	With
Electrical connection	Captive screw clamp terminals solid, 2 x 35 mm ² Captive screw clamp terminals flexible, 2 x 25 mm ²
Tightening torque	2.5 N.m

The information provided in this documentation contains general descriptions and/or technical characteristics of the performance of the products contained herein. This documentation is not intended as a substitute for and is not to be used for determining suitability or reliability of these products for specific user applications. It is the duty of any such user or integrator to perform the appropriate and complete risk analysis, evaluation and testing of the products with respect to the relevant specific application or use thereof. Neither Schneider Electric Industries SAS nor any of its affiliates or subsidiaries shall be responsible or liable for misuse of the information contained herein.

Switching capacity in mA	33000 mA DC at 90 V 3 contact(s) for inductive load (T = 50 ms) 33000 mA DC at 60 V 2 contact(s) for inductive load (T = 50 ms) 33000 mA DC at 30 V 1 contact(s) for inductive load (T = 50 ms) 115000 mA DC at 70 V 3 contact(s) for resistive load (T = 1 ms) 115000 mA DC at 48 V 2 contact(s) for resistive load (T = 1 ms) 115000 mA DC at 24 V 1 contact(s) for resistive load (T = 1 ms) 100000 mA DC at 95 V 2 contact(s) for resistive load (T = 1 ms) 100000 mA DC at 70 V 3 contact(s) for inductive load (T = 50 ms) 100000 mA DC at 48 V 2 contact(s) for inductive load (T = 50 ms) 100000 mA DC at 48 V 1 contact(s) for resistive load (T = 1 ms) 100000 mA DC at 24 V 1 contact(s) for inductive load (T = 50 ms) 100000 mA DC at 140 V 3 contact(s) for resistive load (T = 1 ms)
Mechanical durability	300000 cycles
CAD overall width	88 mm
CAD overall height	88 mm
CAD overall depth	128 mm
Product weight	0.745 kg

Environment

Standards	EN/IEC 60947-3
Product certifications	CULus 480 V 30 hp 3 phases CULus 240 V 20 hp 3 phases CULus 240 V 10 hp 1 phase CULus 120 V 5 hp 1 phase
Protective treatment	TC
Ambient air temperature for operation	-25...55 °C
Ambient air temperature for storage	-40...70 °C
Class of protection against electric shock	Class II conforming to NF C 20-030 Class II conforming to IEC 60536

Dimensions

Rear Mounting

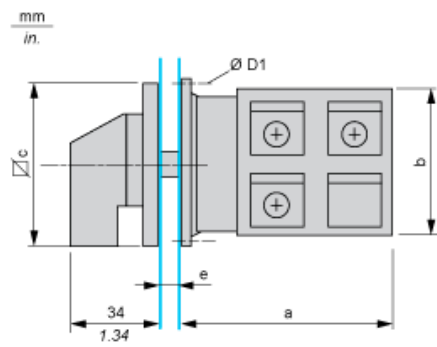

e support panel thickness 0.5 to 5.5 mm / 0.02 to 0.22 in.

a		b		c		D1	
mm	in.	mm	in.	mm	in.	mm	in.
88	3.46	84	3.30	88	3.46	5.4	0.21

Panel Cut-Out

Front Mounting

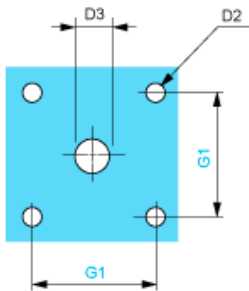

D2		D3		G1	
mm	in.	mm	in.	mm	in.
6	0.24	13	0.51	68	2.68

Link Positions (Factory Mounted)

Diagram for 1 to 6-pole Switches

Select the number of poles according to the product characteristics

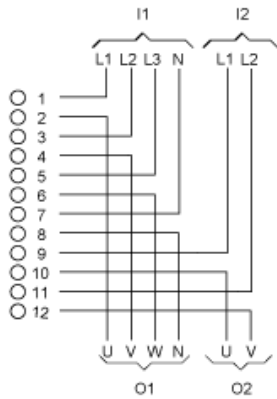

- I1 Input 1
- I2 Input 2
- O1 Output 1
- O2 Output 2

Marking

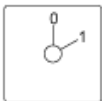

Angular Position of Switch



Switching Program

Diagram for 1 to 6-pole Switches

Select the number of poles according to the product characteristics

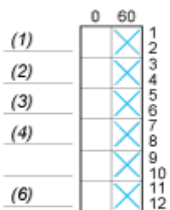



- (1) 1-pole
- (2) 2-pole
- (3) 3-pole
- (4) 4-pole
- (6) 6-pole

Convention Used for Switching Program Representation

 Contact closed

 Contact closed in 2 positions and maintained between the 2 positions

 Sealed assembly for auto-maintain control

 Overlapping contacts

 Spring return position: for a switching angle of 90°, spring return is over 30° after the last position (for a maximum of 3 simultaneous contacts).

Example:

