



## Main

Range of product	Harmony K
Product or component type	Complete cam switch
Component name	K1
[Ith] conventional free air thermal current	12 A
Product mounting	Front mounting
Fixing mode	Ø 22 mm hole
Cam switch head type	With front plate 45 x 45 mm
Type of operator	Black handle, length = 35 mm
Rotary handle padlocking	Without
Presentation of legend	With metallic legend, 2 - 0 - 1 black marking
Cam switch function	Changeover switch
Return	Without
Off position	With Off position
Poles description	2P
Switching positions	Left: 0° - 315° Right: 0° - 45°
IP degree of protection	IP65 conforming to NF C 20-010 IP65 conforming to IEC 529

## Complementary

Switching angle	45 °
[Ui] rated insulation voltage	690 V degree of pollution 3 conforming to IEC 60947-1
[Ithe] conventional enclosed thermal current	10 A
Rated operational power in W	8300 W AC-21 / 400 V 3 phases conforming to IEC 947-3 600 W AC-3 / 230 V 1 phase conforming to IEC 947-3 4800 W AC-21 / 230 V 3 phases conforming to IEC 947-3 2200 W AC-23A / 690 V 3 phases conforming to IEC 947-3 2200 W AC-23A / 500 V 3 phases conforming to IEC 947-3 2200 W AC-23A / 400 V 3 phases conforming to IEC 947-3 1500 W AC-3 / 690 V 3 phases conforming to IEC 947-3 1500 W AC-3 / 500 V 3 phases conforming to IEC 947-3 1500 W AC-3 / 400 V 3 phases conforming to IEC 947-3 1500 W AC-3 / 400 V 1 phase conforming to IEC 947-3 1100 W AC-23A / 230 V 3 phases conforming to IEC 947-3 1100 W AC-3 / 230 V 3 phases conforming to IEC 947-3 10500 W AC-21 / 500...660 V 3 phases conforming to IEC 947-3
[Ie] rated operational current AC	5.6 A at 230 V AC-23A 3 phases conforming to IEC 947-3 4.8 A at 400 V AC-23A 3 phases conforming to IEC 947-3 4.6 A at 230 V AC-3 3 phases conforming to IEC 947-3 3.8 A at 500 V AC-23A 3 phases conforming to IEC 947-3 3.3 A at 400 V AC-3 3 phases conforming to IEC 947-3 2.8 A at 690 V AC-23A 3 phases conforming to IEC 947-3 2.8 A at 500 V AC-3 3 phases conforming to IEC 947-3 1.8 A at 690 V AC-3 3 phases conforming to IEC 947-3 3 A at 230 V AC-15 conforming to IEC 947-5-1 2 A at 400 V AC-15 conforming to IEC 947-5-1 1 A at 500 V AC-15 conforming to IEC 947-5-1
Electrical durability	500000 cycles AC-3 500000 cycles AC-23 1000000 cycles AC-21 1000000 cycles AC-15

Operating rate	8.333 cyc/mn AC-15 2.5 cyc/mn AC-3 2.5 cyc/mn AC-23 2.5 cyc/mn AC-21
Short-circuit current	10000 A
Short circuit protection	16 A by cartridge fuse, type gG
[Uimp] rated impulse withstand voltage	6 kV conforming to IEC 947-1 4 kV in isolating function
Contacts operation	Slow-break
Positive opening	With
Electrical connection	Captive screw clamp terminals solid, 1 x 2.5 mm <sup>2</sup> Captive screw clamp terminals flexible, 2 x 1.5 mm <sup>2</sup>
Mechanical durability	1000000 cycles
CAD overall width	45 mm
CAD overall height	50 mm
CAD overall depth	59 mm
Product weight	0.16 kg

## Environment

Standards	IEC 60947-5-1 for control circuit IEC 60947-3 for power circuit EN 60947-5-1 for control circuit EN 60947-3 for power circuit CENELEC EN 50013
Product certifications	UL 240 V 0.33 hp 1 phase 2 -pole(s) UL 240 V 1 hp 3 phases CSA 240 V 3 hp 3 phases 2 -pole(s) CSA 240 V 1 hp 1 phase
Protective treatment	TC
Ambient air temperature for operation	-25...55 °C
Ambient air temperature for storage	-40...70 °C
Shock resistance	30 gn conforming to IEC 68-2-27
Vibration resistance	5 gn, 10...150 Hz conforming to IEC 68-2-6
Class of protection against electric shock	Class II conforming to NF C 20-030 Class II conforming to IEC 536

---

Operating Head and Body with Plastic Base

---

Front Mounting by  $\varnothing 22$  mm/0.87 in. Hole

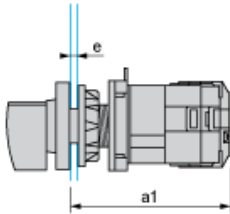

- a1 80.5 mm/3.17 in.
- e support panel thickness 1 mm to 6 mm./0.039 in. to 0.24 in.

Link Positions (Factory Mounted)

Diagram for 1 to 4-pole Switches

Select the number of poles according to the product characteristics.

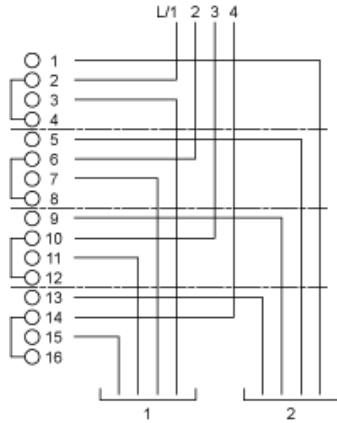

Marking

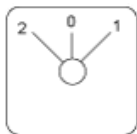

Angular Position of Switch

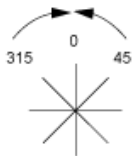

Switching Program

Diagram for 1 to 4-pole Switches

Select the number of poles according to the product characteristics.

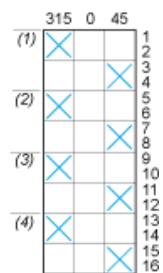



- (1) 1-pole
- (2) 2-pole
- (3) 3-pole
- (4) 4-pole

## Convention Used for Switching Program Representation

---

 Contact closed

 Contact closed in 2 positions and maintained between the 2 positions

 Sealed assembly for auto-maintain control

 Overlapping contacts

 Spring return position: for a switching angle of  $90^\circ$ , spring return is over  $30^\circ$  after the last position (for a maximum of 3 simultaneous contacts).

Example:

