

K2F003ULH

cam changeover switch - 3-pole - 45° - 20 A - screw mounting



Main

Range of product	Harmony K
Product or component type	Complete cam switch
Component name	K2
[Ith] conventional free air thermal current	20 A
Product mounting	Front mounting
Fixing mode	Multifixing
Cam switch head type	With front plate 45 x 45 mm
Type of operator	Black handle, length = 35 mm
Rotary handle padlocking	Without
Presentation of legend	With metallic legend, 2 - 0 - 1 black marking
Cam switch function	Changeover switch
Return	Without
Off position	With Off position
Poles description	3P
Switching positions	Left: 0° - 315° Right: 0° - 45°
IP degree of protection	IP40 conforming to NF C 20-010 IP40 conforming to IEC 529

Complementary

Switching angle	45 °
[Ui] rated insulation voltage	690 V degree of pollution 3 conforming to IEC 60947-1
[Ithe] conventional enclosed thermal current	16 A
Electrical durability	600000 cycles AC-21 600000 cycles AC-15 200000 cycles AC-3 200000 cycles AC-23
Operating rate	8.333 cyc/mn AC-15 2.5 cyc/mn AC-3 2.5 cyc/mn AC-23 2.5 cyc/mn AC-21
Short-circuit current	10000 A
Short circuit protection	20 A by cartridge fuse, type gG
[Uimp] rated impulse withstand voltage	6 kV conforming to IEC 947-1 4 kV in isolating function
Contacts operation	Slow-break
Positive opening	With
Electrical connection	Captive screw clamp terminals solid, 1 x 2.5 mm ² Captive screw clamp terminals flexible, 2 x 1.5 mm ²
Mechanical durability	1000000 cycles
CAD overall width	45 mm
CAD overall height	45 mm
CAD overall depth	97 mm
Product weight	0.17 kg

The information provided in this documentation contains general descriptions and/or technical characteristics of the performance of the products contained herein. This documentation is not intended as a substitute for and is not to be used for determining suitability or reliability of these products for specific user applications. It is the duty of any such user or integrator to perform the appropriate and complete risk analysis, evaluation and testing of the products with respect to the relevant specific application or use thereof. Neither Schneider Electric Industries SAS nor any of its affiliates or subsidiaries shall be responsible or liable for misuse of the information contained herein.

Environment

Standards	IEC 60947-5-1 for control circuit IEC 60947-3 for power circuit EN 60947-5-1 for control circuit EN 60947-3 for power circuit CENELEC EN 50013
Product certifications	UL 240 V 0.33 hp 1 phase 2 -pole(s) UL 240 V 1 hp 3 phases CSA 240 V 3 hp 3 phases 2 -pole(s) CSA 240 V 1 hp 1 phase
Protective treatment	TC
Ambient air temperature for operation	-25...55 °C
Ambient air temperature for storage	-40...70 °C
Shock resistance	30 gn conforming to IEC 68-2-27
Vibration resistance	5 gn, 10...150 Hz conforming to IEC 68-2-6
Class of protection against electric shock	Class II conforming to NF C 20-030 Class II conforming to IEC 536

Operating Head and Body

Front Mounting "Multi-Fixing"

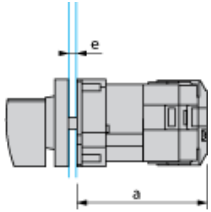

- a 73 mm/2.87 in.
- e support panel thickness 1 mm to 6 mm./0.039 in. to 0.24 in.

Link Positions (Factory Mounted)

Diagram for 1 to 4-pole Switches

Select the number of poles according to the product characteristics.

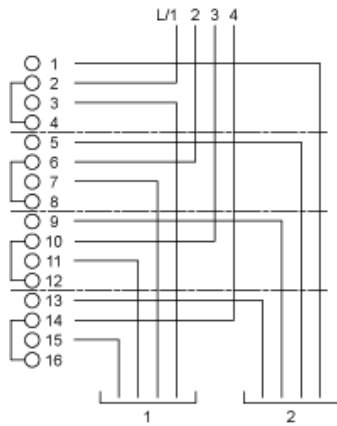

Marking

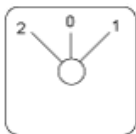

Angular Position of Switch

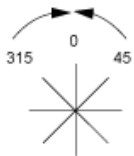

Switching Program

Diagram for 1 to 4-pole Switches

Select the number of poles according to the product characteristics.

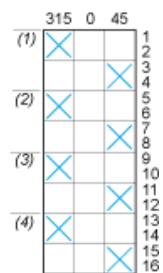



- (1) 1-pole
- (2) 2-pole
- (3) 3-pole
- (4) 4-pole

Convention Used for Switching Program Representation

 Contact closed

 Contact closed in 2 positions and maintained between the 2 positions

 Sealed assembly for auto-maintain control

 Overlapping contacts

 Spring return position: for a switching angle of 90° , spring return is over 30° after the last position (for a maximum of 3 simultaneous contacts).

Example:

