

PRE-WIRED CAP FOR EXACT8, 8XM8, 3 POLE

5.0m PUR/PVC 8x0,34+2x0,75

for 8-way distribution box, 3-pole

Further cable lengths on request.

Plastic housings with good resistance against chemicals and oils.

The resistance to aggressive media should be individually tested for your application. Further details on request.

PUR/PVC

5.0 m

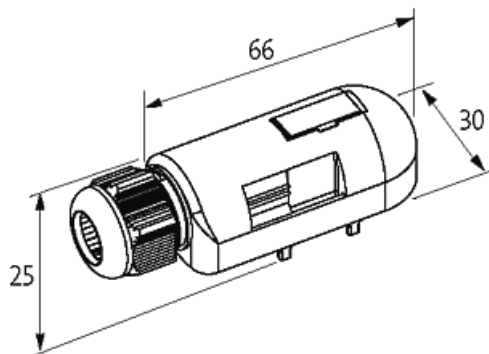
[Link to Product](#)**Illustration**

Product may differ from Image

M8-Females 3-pole

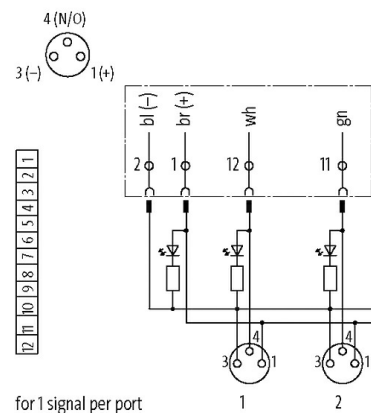
**Technical Data**

Housing	Plastic, flame retardant
Total current	max. 8 A

General data

Temperature range	-20...+80 °C, depending on cable quality
-------------------	--

Cables

Cable number	357
--------------	-----

No./diameter of wires	8× 0.34 + 2× 0.75 mm ²
Wire isolation	PVC (vi, bk, rd, pk, gr, ye, gn, wh+br, bl)
C-track properties	2 Mio.
Jacket Color	gray
Material (jacket)	PUR/PVC
Outer Ø	8.6 mm ±5%
Bend radius (fixed)	5× outer Ø
Bend radius (moving)	10× outer Ø
Temperature range (fixed)	-30...+80 °C
Temperature range (mobile)	-5...+60 °C
Color (jacket)	gray

Commercial data

country of origin	CZ
customs tariff number	85444290
EAN	4048879054584
eClass	27143423
Packaging unit	1