

M12 male 0° / M12 female 0° A-cod. shielded

PUR 5x0.34 shielded gy UL/CSA 4m

Male straight – female straight

M12 – M12, 5-pole

A-coded

shielded

Plastic housings with good resistance against chemicals and oils.

The resistance to aggressive media should be individually tested for your application. Further details on request.

Further cable lengths on request.

[Link to Product](#)

Illustration

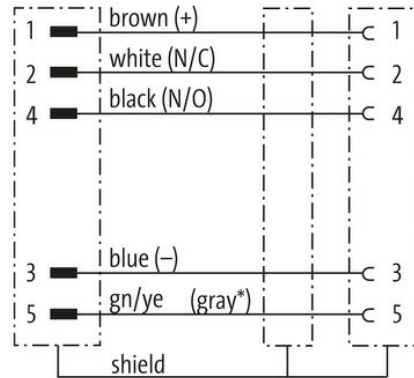

(* for cable type 203, 603, 243, 643)

Male

Female

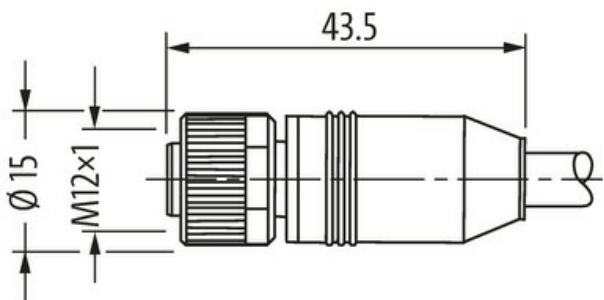
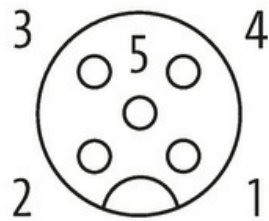

Product may differ from Image



* only for products with UL/CSA approved cable

Form	
Form	40521
Technical Data	
Operating voltage	max. 60 V AC/DC
Operating voltage (only UL listed)	30 V AC/DC
Rated surge voltage	1.5 kV
Operating current per contact	max. 4 A
No. of poles	5
Material group	IEC 60664-1, category I
Coding	A-coded
LED display	no
Locking of ports	Screw thread (M12×1 mm) recommended torque 0.6 Nm, self-securing
Compression gland	M12 (SW13)
Protection	IP65 and IP67 when plugged and screwed down (EN 60529)
Material	PUR
Locking material	Zinc die casting, matte nickel plated
suitable for corrugated tube (internal Ø)	without
General data	
Standards	DIN EN 61076-2-101 (M12)
Mounting method	inserted, tightened
Material (contact)	Copper alloy
Material (contact surface)	Au
Material (gasket)	FKM
Pollution Degree	3
Temperature range	-25...+85 °C, depending on cable quality
Cables	
No./diameter of wires	5× 0.34 mm ²
Wire isolation	PP (br, wh, bl, bk, gnye)
Outer Ø	6.9 mm ±5%
Cable number	351
Approval (cable)	UL (AWM-Style 20233/1992), CSA; CE conform
Diameter (core)	5× 0.34 mm ²
Shield	yes
Color (jacket)	gray
Jacket Color	gray
Temperature range (fixed)	-40...+80 °C
Temperature range (mobile)	-20...+80 °C
Bend radius (fixed)	10× outer Ø
Bend radius (moving)	15× outer Ø
Material (jacket)	PUR (UL/CSA)
Commercial data	
country of origin	CZ
customs tariff number	85444290
EAN	4048879165136

eClass	27279218
Packaging unit	1.000
