

M12 female 90° A-cod. with cable LED

PUR 4x0.34 bk UL/CSA+drag ch. 3.0m

Female 90°
M12, 4-pole
3× LED (PNP)
Art-No. 7005 - M12 Lite - (plastic hexagonal screw) on request
with cable sleeves

Plastic housings with good resistance against chemicals and oils.

The resistance to aggressive media should be individually tested for your application. Further details on request.

Further cable lengths on request.

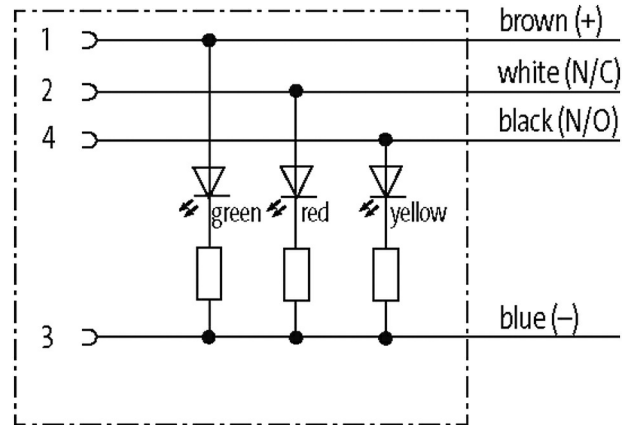
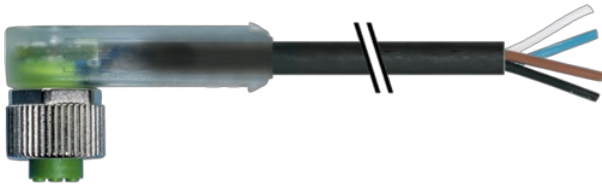
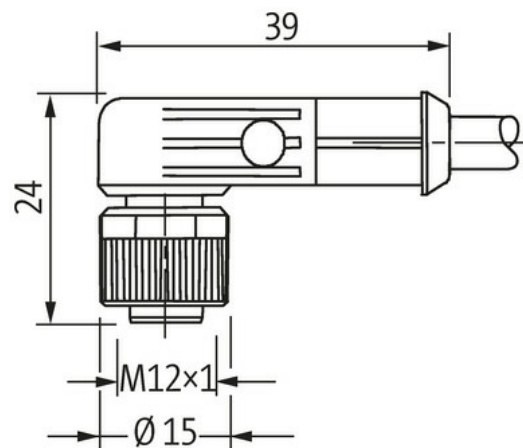
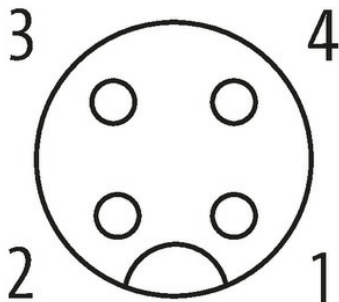
Link to Product**Illustration****Female**

Product may differ from Image

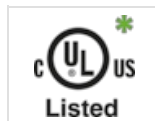

* only for products with UL/CSA approved cable

Form

Form

12423

Technical Data

Operating voltage	24 V DC $\pm 25\%$
Rated surge voltage	0.8 kV
Operating current per contact	max. 4 A
No. of poles	4
Material group	IEC 60664-1, category I
Coding	A-coded
LED display	green, yellow, red
Locking of ports	Screw thread (M12 \times 1 mm) recommended torque 0.6 Nm, self-securing
Compression gland	M12 (SW13)
Protection	IP65, IP66K, IP67 inserted and tightened (EN 60529)
Material	PUR
Locking material	Zinc die casting, matte nickel plated
suitable for corrugated tube (internal \varnothing)	10 mm

General data

Standards	DIN EN 61076-2-101 (M12)
Mounting method	inserted, tightened
Pollution Degree	3
Stripping length (jacket)	20 mm
Temperature range	-25...+85 °C, depending on cable quality

Cables

Cable identification	634
Cable Type	3 (PUR)
Approval (cable)	cURus (AWM-Style 20549/10493); CE conform
Cable weight [g/m]	36,3 g
Material (wire)	Cu wire, bare
Resistor (core)	max. 57 Ω /km (20 °C)
Single wire \varnothing (core)	0.1 mm
Construction (core)	42 \times 0.1 mm (multi-strand wire class 6)
Diameter (core)	4 \times 0.34 mm ²
AWG	similar to AWG 22
Material (wire isolation)	PP
Material property (wire isolation)	CFC-, halogen-, cadmium-, silicone- and lead-free
Shore hardness (wire isolation)	70 \pm 5 D
Wire- \varnothing incl. isolation	1.25 mm $\pm 5\%$
Color/numbering of wires	br, bk, bl, wh
Stranding combination	4 wires twisted
Shield	no
Material (jacket)	PUR
Material property (jacket)	CFC-, halogen-, cadmium-, silicone- and lead-free, matt, low-adhesion, machine easy to process, abrasion-resistant, hydrolysis and microbial resistant
Shore hardness (jacket)	90 \pm 5 A
Outer- \varnothing (jacket)	4.5 mm $\pm 5\%$
Color (jacket)	black
chemical resistance	good resistance to oil, gasoline and chemicals (EN 60811-404)
thermal resistance	flame retardand UL 1581 Section 1090 (H), CSA FT2 / IEC 60332-2-2
Nominal voltage	300 V AC
Test voltage	2500 V AC
Current load capacity	to DIN VDE 0298-4
Temperature range (fixed)	-40...+80 °C, (+90 °C at max. 10 000 operating hours)
Temperature range (mobile)	-25...+80 °C, (+90 °C at max. 10 000 operating hours)
Bend radius (fixed)	5 \times outer \varnothing
Bend radius (moving)	10 \times outer \varnothing
No. of bending cycles (C-track)	max. 10 Mio. (25 °C)

Travel speed (C-track)	max. 3 m/s
Acceleration (C-track)	max. 10 m/s ²
Torsion stress	±180°/m
No. of torsion cycles	max. 2 Mio. (25 °C)
Torsion speed	35 cycles/min

Commercial data

country of origin	DE
customs tariff number	85444290
EAN	4065909021743
eClass	27279218
Packaging unit	1.000