

Valve plug MJC 90° with cable LED+VDR

PUR 2x0.75 bk 3m

Female 90°

10...24 V AC/30 V DC

LED and VDR

Plastic housings with good resistance against chemicals and oils.

The resistance to aggressive media should be individually tested for your application. Further details on request.

Further cable lengths on request.

Link to Product

Illustration

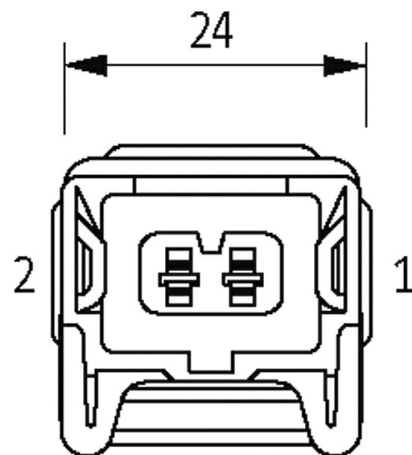
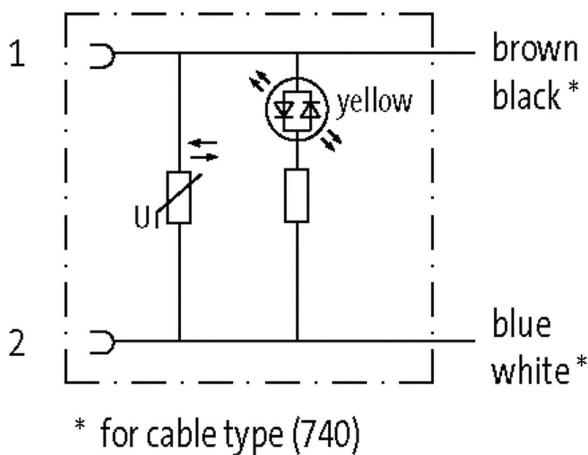
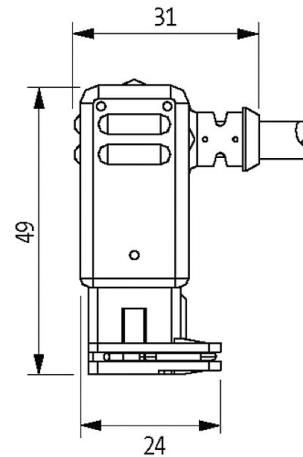

Product may differ from Image

Form

Form 70361

Technical Data

Operating voltage	10...24 V AC/30 V DC
Rated surge voltage	0.8 kV
Operating current per contact	max. 4 A
Current consumption	approx. 12 mA
Material group	IEC 60664-1, category I
LED display	(yellow)
Protection	IP65 inserted and tightened (EN 60529)

The information in this brochure has been compiled with the utmost care.

Liability for the correctness completeness and topicality of the information is restricted to gross negligence. Version: 03/22

Murrelektronik Ltd. | 5 Albion Street, Pendlebury Industrial Estate, Swinton | Manchester M27 4FG | Fon +44 161 728 3133 | Fax +44 161 728 3130 | shop@murrelektronik.co.uk | shop.murrelektronik.co.uk

Housing Black plastic, flame retardant

General data

Pollution Degree 3

Temperature range -25...+85 °C, depending on cable quality

Cables

Cable number 750

No./diameter of wires 2× 0.75 mm²

Wire isolation PVC (br, bl)

Jacket Color black

Material (jacket) PUR/PVC

Outer Ø 5.9 mm ±5%

Bend radius (moving) 15× outer Ø

Temperature range (fixed) -40...+80 °C

Temperature range (mobile) -5...+80 °C

Cable identification 750

Approval (cable) CE conform

Cable weight [g/m] 48,40

Material (wire) Cu wire, bare

Resistor (core) max. 26 Ω/km (20 °C)

Single wire Ø (core) 0.2 mm

Construction (core) 24× 0.2 mm (multi-strand wire class 5)

Diameter (core) 2× 0.75 mm²

AWG similar to AWG 18

Material (wire isolation) PVC

Color/numbering of wires br, bl

Stranding combination 2 wires twisted

Shield no

Material (jacket) PUR/PVC

Outer-Ø (jacket) 5.9 mm ±5%

Color (jacket) black

chemical resistance good resistance to oil, gasoline and chemicals

Nominal voltage 300 V AC

Test voltage 2000 V AC

Temperature range (fixed) -40...+80 °C

Temperature range (mobile) -5...+80 °C

Bend radius (moving) 15× outer Ø

Commercial data

country of origin DE

customs tariff number 85444290

EAN 4048879286381

eClass 27279218

Packaging unit 1