

M12 male 90° A-cod. with cable shielded

PUR 5x0.34 shielded gy 10m

Male 90°
M12, 5-pole
shielded
A-coded

Plastic housings with good resistance against chemicals and oils.

The resistance to aggressive media should be individually tested for your application. Further details on request.
Further cable lengths on request.

[Link to Product](#)

Illustration



(* for cable type 203, 603, 243, 643)

Male

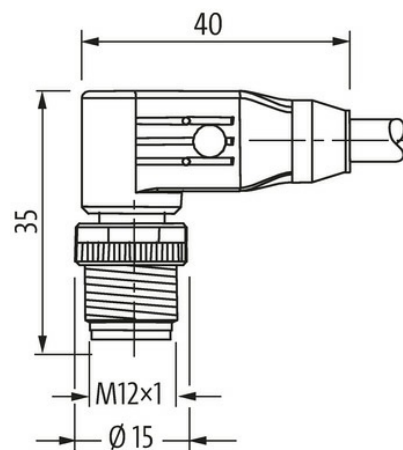

Product may differ from Image



* only for products with UL/CSA approved cable

Form

The information in this brochure has been compiled with the utmost care. Liability for the correctness completeness and topicality of the information is restricted to gross negligence. Version: 03/22

Form	13161
Technical Data	
Operating voltage	max. 60 V AC/DC
Operating voltage (only UL listed)	max. 30 V AC/DC
Rated surge voltage	1.5 kV
Operating current per contact	max. 4 A
Material group	IEC 60664-1, category I
Coding	A-coded
Locking of ports	Screw thread (M12×1 mm) recommended torque 0.6 Nm, self-securing
Compression gland	M12 (SW13)
Protection	IP65, IP66K, IP67 inserted and tightened (EN 60529)
Material	PUR
Locking material	Zinc die casting, matte nickel plated
General data	
Standards	DIN EN 61076-2-101 (M12)
Material (contact)	Copper alloy
Material (contact surface)	Au
Pollution Degree	3
Temperature range	-25...+85 °C, depending on cable quality
Cables	
No./diameter of wires	5× 0.34 mm ²
Wire isolation	PVC (br, wh, bl, bk, gnye)
C-track properties	0.1 Mio.
Outer Ø	5.9 mm ±5%
Cable number	349
Approval (cable)	CE conform
Shield	yes
Color (jacket)	gray
Jacket Color	gray
Temperature range (fixed)	-40...+80 °C
Temperature range (mobile)	-5...+70 °C
Bend radius (fixed)	10× outer Ø
Bend radius (moving)	15× outer Ø
Material (jacket)	PUR/PVC
Commercial data	
country of origin	CZ
customs tariff number	85444290
EAN	4048879200448
eClass	27279218
Packaging unit	1.000