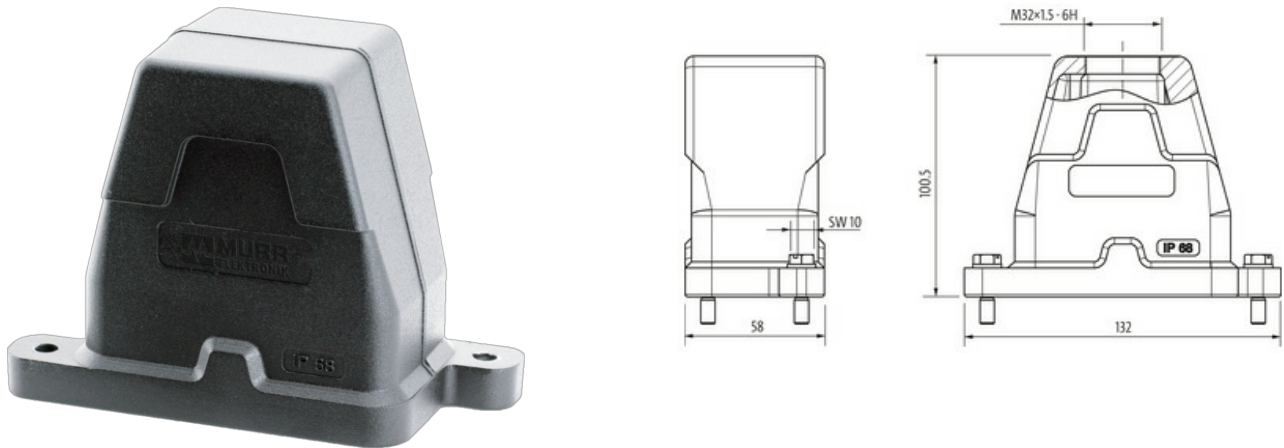

B6 Hood, IP68

Screw locking, top entry M32

B6
Hood
Screw locking
IP68

Technical data will be only guaranteed with Murrelektronik components.

[Link to Product](#)**Illustration**

Product may differ from Image

Technical Data

Mating cycles	min. 500
Locking of ports	Screw locking
Protection (housing)	IP68 inserted and tightened (EN 60529), with gland
Tightening torque	4 Nm

General data

Material (gasket)	Silicon
Temperature range	-40...+125 °C
Material (housing)	Aluminum die-cast
Housing type	Hood
Threaded hole	M32
Size	B6
Cable outlet	straight
Locking material	Stainless steel
Climatic category	40/125/21
Material (housing surface)	powder-coated
Dimensions H×W×D	100.5×58×132 mm

Commercial data

country of origin	CZ
customs tariff number	85389099
EAN	4048879647342
eClass	27143424
Packaging unit	1.000