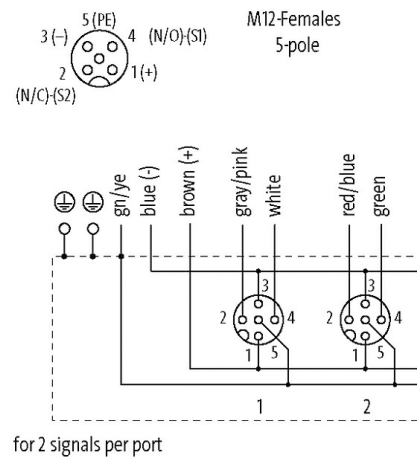
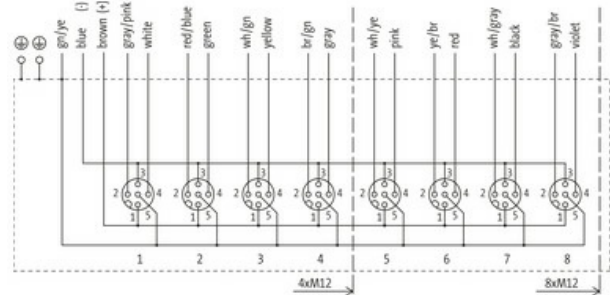
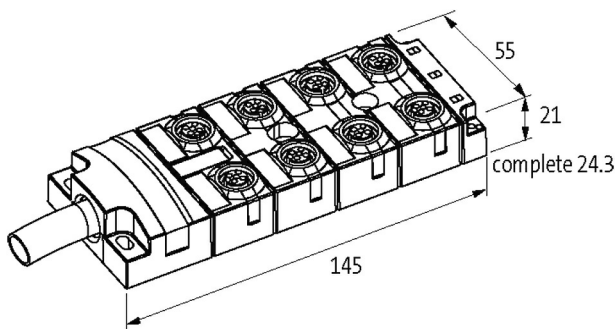

**MVP-METALL, 8XM12, 5POLE, PRE-WIRED CABLE**

3.0m PUR 16x0,5+3x1,0, UL/CSA

3.0 m

Replaces identical product (Art.No. 27496)

[Link to Product](#)**Illustration**

Product may differ from Image

**Technical Data**

Operating voltage	max. 125 V AC/DC
Operating current per contact	max. 4 A
Locking of ports	Screw thread (M12×1 mm)
Protection	IP65, IP67, IP68
Housing	Zinc die casting, matte nickel plated

**General data**

Temperature range	-20...+90 °C, depending on cable quality
-------------------	--

**Cables**

Cable identification	452
Approval (cable)	cRUus (AWM style 20549/10042); CE compliant
Cable weight [g/m]	231 g

Material (wire)	Cu wire, bare
Resistor (core)	max. 39 Ω/km (0.5 mm <sup>2</sup> ); max. 20 Ω/km (1.0 mm <sup>2</sup> ); (20 °C)
Single wire Ø (core)	0.1 mm
Construction (core)	64× 0.1 mm (0.5 mm <sup>2</sup> ), 128× 0.1 mm (1.0 mm <sup>2</sup> ); (multi-strand wire class 6)
Diameter (core)	16× 0.5 + 3× 1.0 mm <sup>2</sup>
AWG	similar to AWG 20 (0.5 mm <sup>2</sup> ); similar to AWG 17 (1.0 mm <sup>2</sup> )
Material (wire isolation)	TPE-E
Shore hardness (wire isolation)	55 ±3 D
Wire-Ø incl. isolation	1.6 mm ±5% (0.5 mm <sup>2</sup> ); 2.1 mm ±5% (1.0 mm <sup>2</sup> )
Material (jacket)	PUR
Material property (jacket)	CFC-, halogen-, cadmium-, silicone- and lead-free, matt, low-adhesion, machine easy to process, abrasion-resistant, hydrolysis and microbial resistant
Shore hardness (jacket)	94 ±5 A
Outer-Ø (jacket)	11.5 mm ±5%
Color (jacket)	gray
chemical resistance	good resistance to oil, gasoline and chemicals
thermal resistance	flame retardand UL 1581 Section 1090 (H), CSA FT2 / IEC 60332-2-2
Nominal voltage	300/300 V AC
Test voltage	2000 V AC
Current load capacity	to DIN VDE 0298-4
Temperature range (mobile)	-20...+90 °C
Bend radius (moving)	10× outer Ø
No. of bending cycles (C-track)	max. 5 Mio.
Traversing distance (C-track)	max. 5 m (horizontal)
Travel speed (C-track)	max. 2 m/s
Acceleration (C-track)	max. 5 m/s <sup>2</sup>

#### Contact Layout

PIN 1	(+)
PIN 2	(NC)/(S2)
PIN 3	(-)
PIN 4	(NO)/(S1)
PIN 5	(Earth)

#### Commercial data

country of origin	CZ
customs tariff number	85444290
EAN	4048879351966
eClass	27279219
Packaging unit	1.000