

MSUD valve plug A-18mm with cable

PUR 4x0.75 gy UL/CSA 5m

MSUD

Form A (18 mm)

0...230 V AC/DC

without components

4-pole

PE opposite cable entry (180°)

Further cable lengths on request.

Plastic housings with good resistance against chemicals and oils.

The resistance to aggressive media should be individually tested for your application. Further details on request.

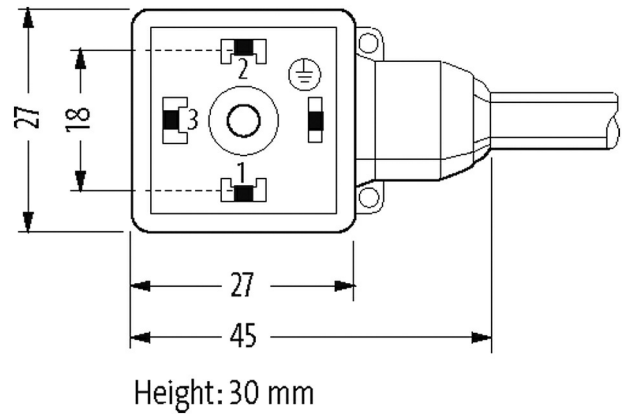
Link to Product**Illustration**

Product may differ from Image

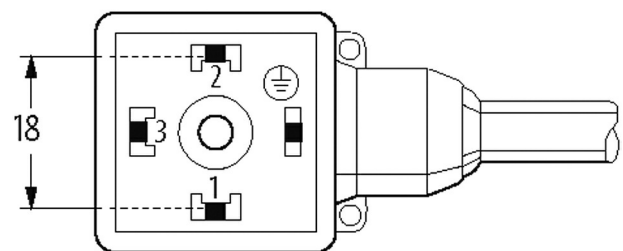
**Form**

Form 18112

Technical Data

Operating voltage max. 230 V AC/DC

Operating current per contact	max. 10 A
Rated surge voltage	4.0 kV
Material group	IEC 60664-1, category I
Locking of ports	M3 (recommended torque 0.4 Nm)
Protection	IP67
Locking material	Steel (galvanized)
Material	PBT
Housing	Black plastic (gray on request)

General data

Pollution Degree	3
Material (gasket)	PUR
Temperature range	-25...+85 °C, depending on cable quality

Cables

No./diameter of wires	4× 0.75 mm ²
Wire isolation	PVC (bk num, gnye)
C-track properties	2 Mio.
Material (jacket)	PUR/PVC (UL/CSA)
Outer Ø	7.0 mm ±5%
Bend radius (moving)	15× outer Ø
Temperature range (fixed)	-30...+80 °C
Temperature range (mobile)	-5...+80 °C
Cable identification	227
Cable Type	2 (PUR/PVC)
Approval (cable)	UL (AWM-Style 20549/1731), CSA; CE conform
Cable weight [g/m]	80,19
Material (wire)	Cu wire, bare
Resistor (core)	max. 26 Ω/km (20 °C)
Single wire Ø (core)	0.15 mm
Construction (core)	42× 0.15 mm (multi-strand wire class 6)
Diameter (core)	4× 0.75 mm ²
AWG	similar to AWG 18
Material (wire isolation)	PVC
Material property (wire isolation)	CFC-, cadmium-, silicone- and lead-free
Shore hardness (wire isolation)	43 ±5 D
Wire-Ø incl. isolation	1.8 mm ±5%
Color/numbering of wires	bk numbered, gnye longitudinally striped
Stranding combination	4 wires twisted
Shield	no
Material (jacket)	PUR/PVC
Material property (jacket)	CFC-, halogen-, cadmium-, silicone- and lead-free, matt, low-adhesion, machine easy to process, abrasion-resistant, hydrolysis and microbial resistant
Shore hardness (jacket)	80 ±5 A (PVC-under jacket); 85 ±5 A (PUR-jacket)
Outer-Ø (jacket)	7.0 mm ±5%
Color (jacket)	gray
chemical resistance	good resistance to oil, gasoline and chemicals
Nominal voltage	UL 300 V AC
Test voltage	2000 V AC
Current load capacity	to DIN VDE 0298-4
Temperature range (fixed)	-30...+80 °C
Temperature range (mobile)	-5...+80 °C
Bend radius (fixed)	10× outer Ø
Bend radius (moving)	15× outer Ø
No. of bending cycles (C-track)	max. 2 Mio. (25 °C)

The information in this brochure has been compiled with the utmost care.

Liability for the correctness completeness and topicality of the information is restricted to gross negligence. Version: 03/22

Traversing distance (C-track)	max. 5 m (horizontal)
-------------------------------	-----------------------

Travel speed (C-track)	max. 3.3 m/s
------------------------	--------------

Acceleration (C-track)	max. 5 m/s ²
------------------------	-------------------------

Jacket Color	gray
--------------	------

Commercial data

country of origin	CZ
-------------------	----

customs tariff number	85444290
-----------------------	----------

EAN	4048879190923
-----	---------------

eClass	27279218
--------	----------

Packaging unit	1
----------------	---