

MQ15-X-Power fem. receptacle shielded front mount

wires PVC 4x2.5 0,5m

Female straight
MQ15, 4-pole
with multi-strand wire
shielded housing
Front mounting

Plastic housings with good resistance against chemicals and oils.

The resistance to aggressive media should be individually tested for your application. Further details on request.
Further cable lengths on request.

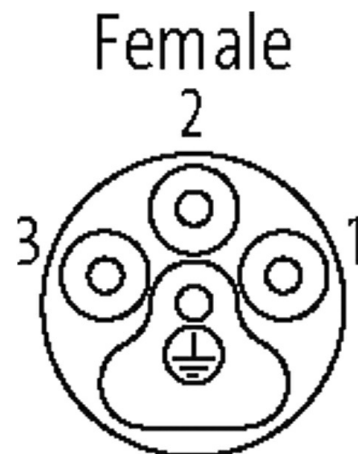
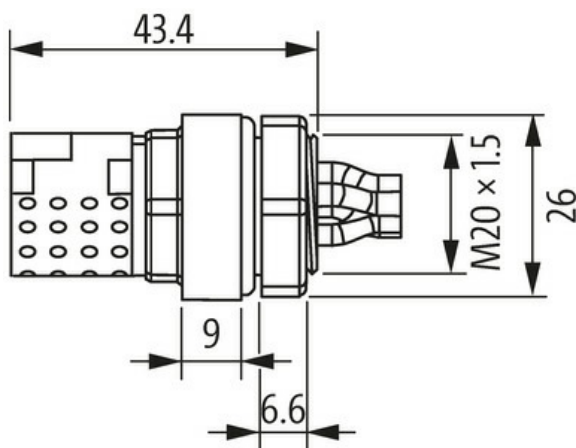
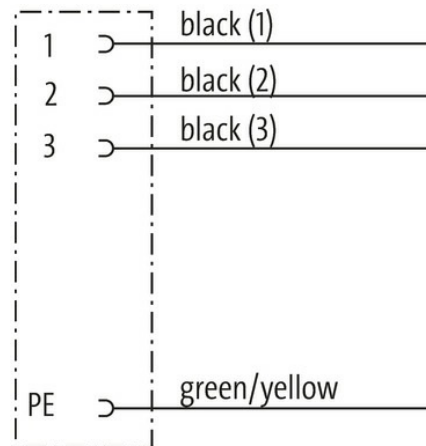
[Link to Product](#)**Illustration**

Product may differ from Image

Form

Form P8291

Technical Data

Operating voltage	max. 600 V AC
Rated surge voltage	2.5 kV
Operating current per contact	max. 16 A
No. of poles	4
Material group	IEC 60664-1, category I

Mating cycles	≥ 500
LED display	no
Locking of ports	Quick connection, 1/4 turn
Protection	IP67 inserted and tightened (EN 60529)
Material	Brass, nickel plated
Configuration	fully used

General data

Mounting method	inserted, tightened
Material (contact)	Copper alloy
Material (contact surface)	Ag
Pollution Degree	3
Temperature range	-40...+70 °C, depending on cable quality
Material (contact carrier)	PA

Cables

No./diameter of wires	4x 2.5 mm ²
Wire isolation	PVC (bk num, gnye)
Outer Ø	3.7 mm ±5%
Cable identification	P82
Cable number	P82
Material (wire)	Cu wire, tin plated
Construction (core)	multi-strand wire class 5 (EN 60228)
Diameter (core)	4x 2.5 mm ²
AWG	similar to AWG 14
Material (wire isolation)	PVC
Wire-Ø incl. isolation	3.7 mm ±5%
Color/numbering of wires	bk numbered, gnye longitudinally striped
thermal resistance	flame retardant UL VW1, CSA FT1
Nominal voltage	600 V
Test voltage	2500 V AC
Temperature range (fixed)	-40...+70 °C (+90 °C UL-MTW, +105 °C UL-AWM , +105 °C CSA-TEW)

Commercial data

country of origin	DE
customs tariff number	85444290
EAN	4048879702096
eClass	27279220
Packaging unit	1.000