

SIEMENS CONTACTOR SUPPRESSOR

RC, 110VAC/DC

110 V AC/DC

RC

For other configurations and voltages, please inquire.

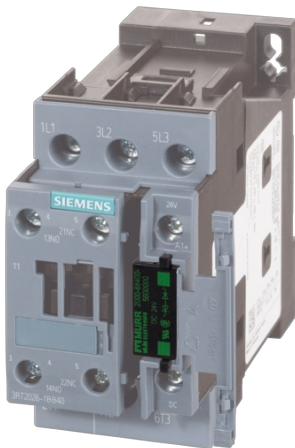
[Link to Product](#)**Illustration**

RC

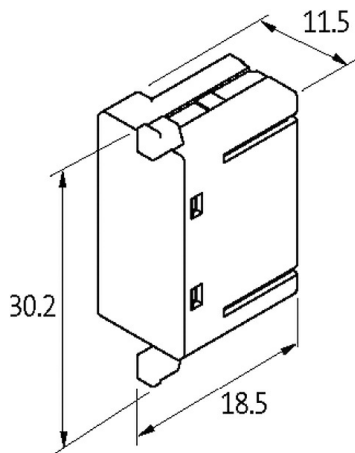

Product may differ from Image

**Technical Data**

Input voltage	48...150 V AC/DC
Material	Flame retardant plastic acc. to (UL 94)
Damping factor	approx. 1.5× UN
Connection wires	Plug contact

General data

Temperature range	-20...+70 °C
-------------------	--------------

Dimensions H×W×D 18.5×30.2×11.5 mm

Appropriate contactors

3 RT 20.25/26/27/28

Commercial data

country of origin	CZ
customs tariff number	85363010
EAN	4048879010771
eClass	27371013
Packaging unit	1.000