

MSUD valve plug A-18mm with cable F&B

PVC 3x0.75 gy 5m

F&B MSUD

The resistance to aggressive media should be individually tested for your application. Further details on request.

Form A (18 mm)

24 V AC/DC $\pm 25\%$

LED and suppression

3-pole

Stainless steel 1.4578 (V4A)

Bridged PE

Further cable lengths on request.

Plastic housings with good resistance against chemicals and oils.

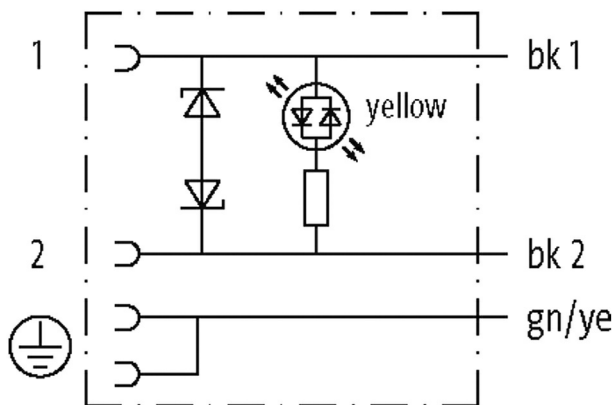
Link to Product**Illustration**

Product may differ from Image

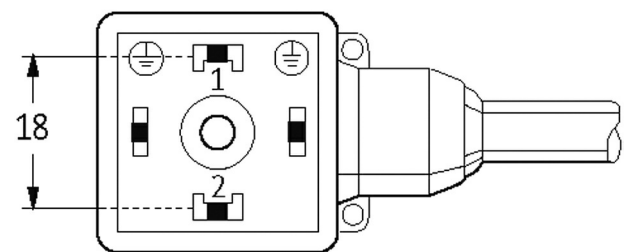
**Form**

Form

18021

Technical Data

Operating voltage

24 V AC/DC $\pm 25\%$

Rated surge voltage	0.8 kV
Operating current per contact	max. 4 A
Current consumption	approx. 12 mA
Material group	IEC 60664-1, category I
Switch off peak	max. 55 V
Switch off delay time	max. 20 ms
LED display	yellow
Locking of ports	M3 (recommended torque 0.4 Nm)
Protection	IP65, IP68, IP69K inserted and tightened (EN 60529)
Locking material	Stainless steel 1.4578 (V4A)
Material	PBT
Housing	Gray plastic
Additional suppressor	Diode/Z-Diode

General data

Pollution Degree	3
Material (gasket)	PUR
Temperature range	-25...+85 °C, depending on cable quality

Cables

No./diameter of wires	3× 0.75 mm ²
Wire isolation	PVC (bk num, gnye)
Material (jacket)	PVC
Outer Ø	5.9 mm ±5%
Bend radius (moving)	10× outer Ø
Temperature range (fixed)	-30...+70 °C
Temperature range (mobile)	-5...+70 °C
Cable identification	216
Cable Type	1 (PVC)
Approval (cable)	CE conform
Cable weight [g/m]	63,80
Material (wire)	Cu wire, bare
Resistor (core)	max. 26 Ω/km (20 °C)
Single wire Ø (core)	0.2 mm
Construction (core)	24× 0.2 mm (multi-strand wire class 5)
Diameter (core)	3× 0.75 mm ²
AWG	similar to AWG 18
Material (wire isolation)	PVC
Material property (wire isolation)	CFC-, cadmium-, silicone- and lead-free
Shore hardness (wire isolation)	43 ±5 D
Wire-Ø incl. isolation	1.8 mm ±5%
Color/numbering of wires	bk numbered, gnye longitudinally striped
Stranding combination	3 wires twisted
Shield	no
Material (jacket)	PVC
Material property (jacket)	CFC-, cadmium-, silicone- and lead-free
Shore hardness (jacket)	80 ±5 A
Outer-Ø (jacket)	5.9 mm ±5%
Color (jacket)	gray
chemical resistance	good resistance to oil, gasoline and chemicals
Nominal voltage	300/500 V AC
Test voltage	3000 V AC
Current load capacity	to DIN VDE 0298-4
Temperature range (fixed)	-30...+70 °C
Temperature range (mobile)	-5...+70 °C

The information in this brochure has been compiled with the utmost care.

Liability for the correctness completeness and topicality of the information is restricted to gross negligence. Version: 03/22

Bend radius (fixed)	5× outer Ø
Bend radius (moving)	10× outer Ø
Jacket Color	gray
Commercial data	
country of origin	CZ
customs tariff number	85444290
EAN	4048879108515
eClass	27279218
Packaging unit	1