

MOSA M8 FEMALE 0° FIELD-WIREABLE (IDC)4-pol., 0,14-0,34mm²

IDC terminals

Female straight

M8, 4-pole

Connection cross section: 0.14...0.34 mm²[Link to Product](#)**Illustration**

Female

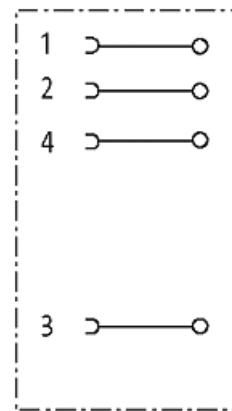
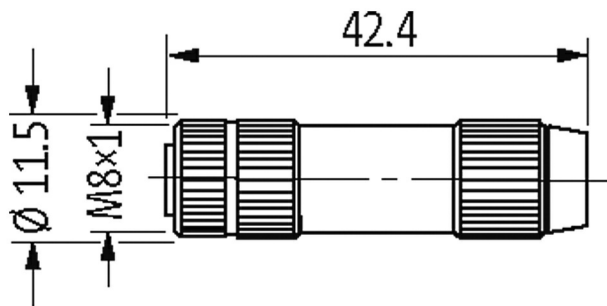
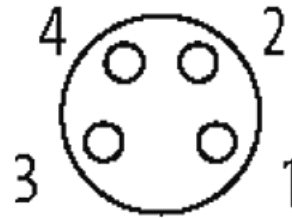

Product may differ from Image

**Form**

Form 08391

Technical Data

Operating voltage	max. 32 V AC/DC
Rated surge voltage	0.8 kV
Operating current per contact	max. 4 A
No. of poles	4
Configuration	fully used
Material group	IEC 60664-1, category I

Over voltage category	3
Isolation resistance	$\geq 10^8 \Omega$
Contact resistance	$\leq 10 \text{ m}\Omega$
Connection cross section	0.14...0.34 mm ² (conductor diameter min. 0.1 mm)
Sealing range (cable Ø)	2.5...5.1 mm (gasket included)
Outer wire Ø	1.0...1.6 mm
Locking of ports	Screw thread (M8×1 mm) recommended torque 0.4 Nm, self-securing
Compression gland	M8 (SW9)
Protection	IP67 inserted and tightened (EN 60529)
Wire isolation	PVC, PP, TPE
Material	PA
Locking material	Zinc die casting, matte nickel plated
Mating cycles	≥ 100
Reconnection (cable)	10

General data

Standards	DIN EN 61076-2-104 (M8)
Connection	Insulation displacement technology IDC
Mounting method	inserted, tightened
Material (contact)	Copper alloy
Dimensions H×W×D	42.5×11.8×11.8 mm
Pollution Degree	3
Temperature range	-25...+85 °C

Commercial data

country of origin	DE
customs tariff number	85366990
EAN	4048879224673
eClass	27279221
Packaging unit	1