

M12 male 90° / M12 female 90° A-cod. shielded

PUR 4x0.5+2x0.25 shielded gn UL/CSA+drag ch. 9m

Cube67

Male 90° – female 90°

M12 – M12, 6-pole

A-coded

shielded

Hybrid cable

Plastic housings with good resistance against chemicals and oils.

The resistance to aggressive media should be individually tested for your application. Further details on request.

Further cable lengths on request.

[Link to Product](#)**Illustration**

Male



Female

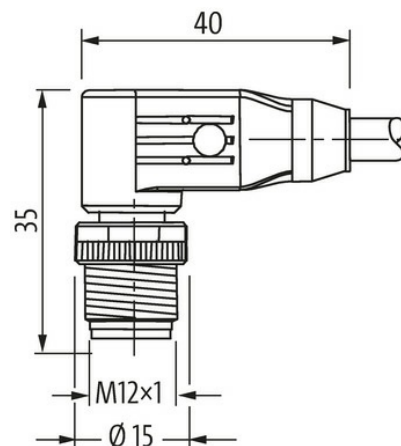



Product may differ from Image



* only for products with UL/CSA approved cable

Form

Form 46061

Technical Data

Operating voltage	max. 30 V AC/DC
Operating voltage (only UL listed)	30 V AC/DC
Rated surge voltage	0.8 kV
Operating current per contact	max. 4 A
No. of poles	6
Material group	IEC 60664-1, category I
Coding	A-coded
LED display	no
Locking of ports	Screw thread (M12x1 mm) recommended torque 0.6 Nm, self-securing
Compression gland	M12 (SW13)
Protection	IP65 and IP67 when plugged and screwed down (EN 60529)
Locking material	Zinc die casting, matte nickel plated
suitable for corrugated tube (internal Ø)	without

General data

Mounting method	inserted, tightened
Material (contact)	Copper alloy
Material (contact surface)	Au
Material (gasket)	FKM
Pollution Degree	3
Temperature range	-25...+85 °C, depending on cable quality

Cables

No./diameter of wires	4x 0.5 + 2x 0.25 mm ²
Wire isolation	TPE (bl, wh, br, bk), (gr, pk)
C-track properties	5 Mio.
Outer Ø	7.9 mm ±5%
Cable identification	802
Approval (cable)	cRUus (AWM style 20549/10042); CE compliant
Cable weight [g/m]	95,7 g
Material (wire)	Cu wire, bare
Single wire Ø (core)	0.15 mm (0.5 mm ²); 0.1 mm (0.25 mm ²)

The information in this brochure has been compiled with the utmost care.

Liability for the correctness completeness and topicality of the information is restricted to gross negligence. Version: 03/22

Construction (core)	28× 0.15 mm (0.5 mm ²); 32× 0.1 mm (0.25 mm ²); (multi-strand wire class 6)
Diameter (core)	4× 0.5 + 2× 0.25 mm ²
AWG	similar to AWG 20 (0.5 mm ²); similar to AWG 24 (0.25 mm ²)
Material (wire isolation)	TPE-E
Shore hardness (wire isolation)	55 ±5 D
Wire-Ø incl. isolation	1.5 mm ±5% (0.5 mm ²); 1.4 mm ±5% (0.25 mm ²)
Color/numbering of wires	(bl, wh, br, bk) + (gr, pk)
Shield	yes
optical shield cover	min. 80%
Material (jacket)	PUR
Material property (jacket)	CFC-, halogen-, cadmium-, silicone-free, matt, low-adhesion, machine easy to process, abrasion-resistant
Shore hardness (jacket)	89 ±5 A
Outer-Ø (jacket)	7.9 mm ±5%
Color (jacket)	green
Jacket Color	green
Nominal voltage	300 V AC
Test voltage	1500 V (wire/wire); 1200 V (wire/shield)
Temperature range (fixed)	-50...+80 °C
Temperature range (fixed)	-50...+80 °C
Temperature range (mobile)	-40...+80 °C
Temperature range (mobile)	-40...+80 °C
Bend radius (fixed)	5× outer Ø
Bend radius (moving)	10× outer Ø
Bend radius (moving)	10× outer Ø
No. of bending cycles (C-track)	max. 5 Mio. (25 °C)
Travel speed (C-track)	max. 2 m/s
Torsion stress	±180°/m
Material (jacket)	PUR (UL/CSA)

Commercial data

country of origin	HU
customs tariff number	85444290
EAN	4048879140010
eClass	27061801
Packaging unit	1.000