

RJ45 male 45° left / RJ45 male 45° left shielded

PVC 1x4xAWG22 shielded gn UL/CSA+drag ch. 20m

Ethernet CAT5

Male 45° left – male 45° left

RJ45 – RJ45, 8/4-pole shielded

Further cable lengths on request.

Plastic housings with good resistance against chemicals and oils.

The resistance to aggressive media should be individually tested for your application. Further details on request.

[Link to Product](#)

Illustration

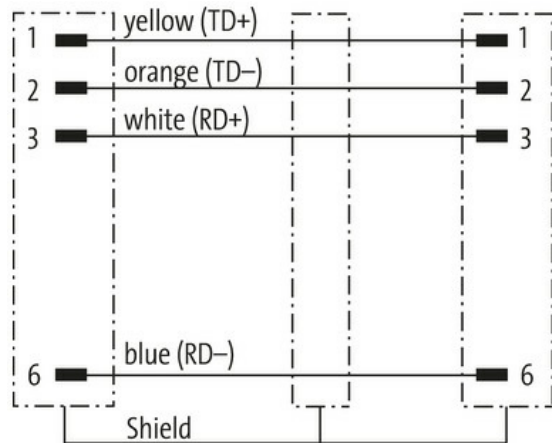
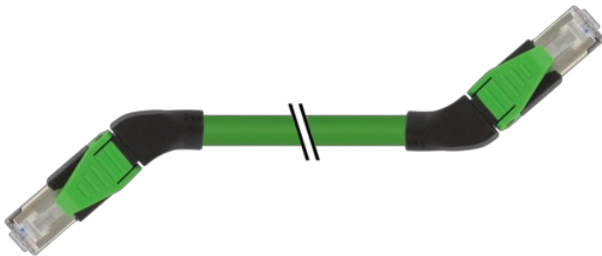

Male



Male

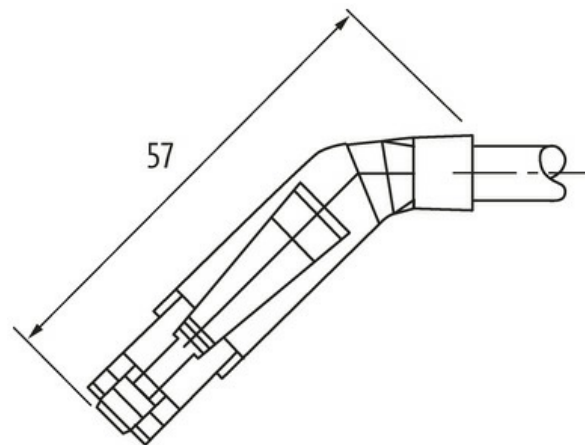

Product may differ from Image

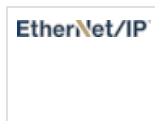

* only for products with UL/CSA approved cable

Form

The information in this brochure has been compiled with the utmost care. Liability for the correctness completeness and topicality of the information is restricted to gross negligence. Version: 03/22

Form	74541
Technical Data	
Operating voltage	max. 60 V DC
Operating voltage (only UL listed)	max. 30 V DC
Rated surge voltage	1.0 kV
Operating current per contact	max. 1.5 A (20 °C)
Transfer parameters	CAT5, Class D (ISO/IEC 11801:2002), (EN 50173-1)
Transfer rate	up to 100 Mbit/s full duplex
Material group	IEC 60664-1, category I
Protection	IP20
Material	PUR
Locking material	PA
suitable for corrugated tube (internal Ø)	without
General data	
Pollution Degree	3
Temperature range	-25...+85 °C, depending on cable quality
Cables	
Cable identification	800
Approval (cable)	UL (AWM-Style 2571/10578), CSA; CE conform; Profinet Guideline
Cable weight [g/m]	73,7 g
Material (wire)	Cu wire, bare
Resistor (core)	max. 55 Ω/km (20 °C)
Construction (core)	7 × 0.254 mm
Diameter (core)	1 × 4 × AWG22/7
AWG	similar to AWG 22
Material (wire isolation)	PE
Shore hardness (wire isolation)	55 ± 5 D
Wire-Ø incl. isolation	1.52 mm ± 5%
Color/numbering of wires	wh, ye, bl, or
Shield	yes
optical shield cover	min. 85%
Material (jacket)	PVC
Shore hardness (jacket)	85 ± 5 A
Outer-Ø (jacket)	6.5 mm ± 5%
Color (jacket)	green
chemical resistance	Oil resistance IEC 60811-2-1, ASTM Öle 1, ICEA S-82-552 Std.
thermal resistance	flammwidrig nach UL 1581 Section 1060 (FT1), Section 1061 (cable flame), IEC 60332-1-2
Nominal voltage	300 V AC
Test voltage	2000 V AC (test duration 1 min)
Temperature range (fixed)	-30...+80 °C
Temperature range (mobile)	-10...+70 °C
Bend radius (fixed)	5 × outer Ø
Bend radius (moving)	15 × outer Ø
No. of bending cycles (C-track)	max. 2 Mio. (25 °C)
Travel speed (C-track)	max. 3.3 m/s
Acceleration (C-track)	max. 2 m/s
Commercial data	
country of origin	DE
customs tariff number	85444210
EAN	4048879663205
eClass	27061801

Packaging unit

1.000