

MVP12, 4XM12, 4POLE, PLUGGABLE CABLE

15.0m PUR/PVC 8x0,34+5x0,75, w/o LED's

4-way, 5-pole

PUR/PVC

15.0 m

Potential separation as option

Further cable lengths on request.

Plastic housings with good resistance against chemicals and oils.

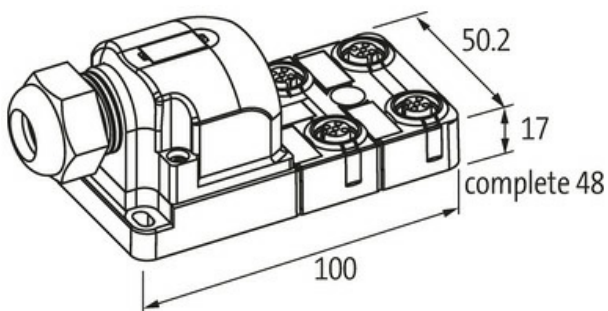
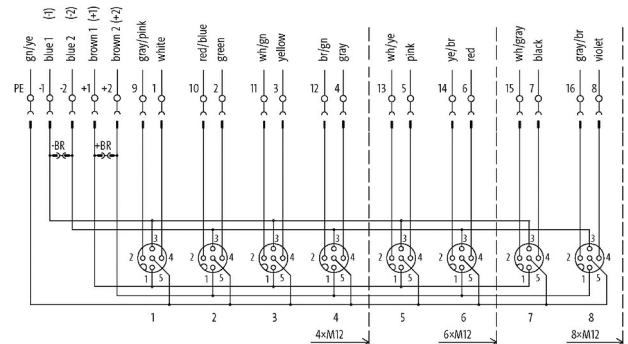
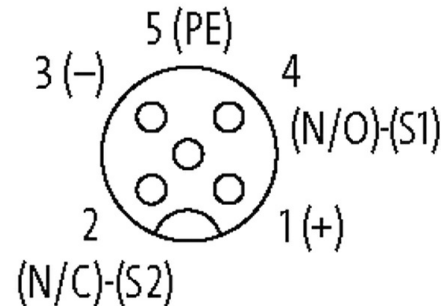
Link to Product**Illustration****M12 Females 5-pole**

Product may differ from Image

**Technical Data**

Operating voltage	24 V DC
Operating current per contact	max. 4 A
Locking of ports	Screw thread (M12x1 mm)
Protection	IP67 inserted and tightened (EN 60529)
Housing	Plastic, flame retardant
Signal per port	2
Total current	max. 2x 8 A

General data	
Temperature range	-20...+80 °C
Dimensions HxWxD	99.2x50.2x17.2 mm
Cables	
No./diameter of wires	8x 0.34 + 5x 0.75 mm ²
Wire isolation	PVC
C-track properties	1.5 Mio.
Outer Ø	9.2 mm ±5%
Cable number	374
Color (jacket)	gray
Jacket Color	gray
Temperature range (fixed)	-30...+80 °C
Temperature range (mobile)	-30...+80 °C
Bend radius (fixed)	10x outer Ø
Bend radius (moving)	12x outer Ø
Material (jacket)	PUR/PVC
Contact Layout	
PIN 1	(+)
PIN 2	(NC)/(S2)
PIN 3	(-)
PIN 4	(NO)/(S1)
PIN 5	(Earth)
Commercial data	
country of origin	CZ
customs tariff number	85444290
EAN	4048879059473
eClass	27279219
Packaging unit	1.000