

Valve plug MJC 0° with cable LED+VDR

PUR 2x0.75 bk 15m

Female straight

10...24 V AC/30 V DC

LED and VDR

Plastic housings with good resistance against chemicals and oils.

The resistance to aggressive media should be individually tested for your application. Further details on request.

Further cable lengths on request.

[Link to Product](#)

Illustration

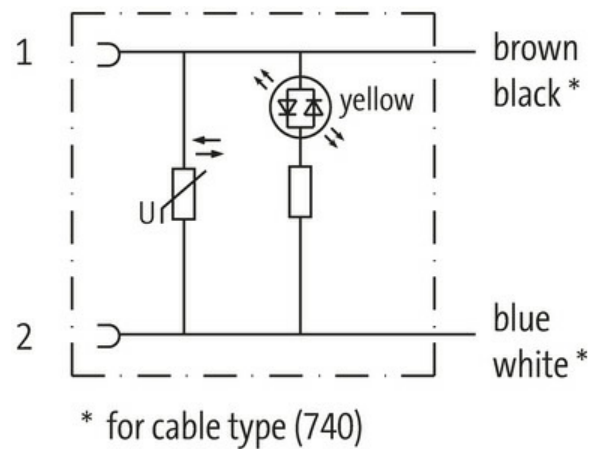

Product may differ from Image

Form

Form 70061

Technical Data

Operating voltage	10...24 V AC/30 V DC
Rated surge voltage	0.8 kV
Operating current per contact	max. 4 A
Current consumption	approx. 12 mA
LED display	(yellow)
Protection	IP65 inserted and tightened (EN 60529)

The information in this brochure has been compiled with the utmost care.

Liability for the correctness completeness and topicality of the information is restricted to gross negligence. Version: 03/22

Murrelektronik Ltd. | 5 Albion Street, Pendlebury Industrial Estate, Swinton | Manchester M27 4FG | Fon +44 161 728 3133 | Fax +44 161 728 3130 | shop@murrelektronik.co.uk | shop.murrelektronik.co.uk

Housing Black plastic, flame retardant

General data

Temperature range -25...+85 °C, depending on cable quality

Cables

Cable identification	750
Approval (cable)	CE conform
Cable weight [g/m]	48,4 g
Material (wire)	Cu wire, bare
Resistor (core)	max. 26 Ω/km (20 °C)
Single wire Ø (core)	0.2 mm
Construction (core)	24× 0.2 mm (multi-strand wire class 5)
Diameter (core)	2× 0.75 mm ²
AWG	similar to AWG 18
Material (wire isolation)	PVC
Color/numbering of wires	br, bl
Stranding combination	2 wires twisted
Shield	no
Material (jacket)	PUR/PVC
Outer-Ø (jacket)	5.9 mm ±5%
Color (jacket)	black
chemical resistance	good resistance to oil, gasoline and chemicals
Nominal voltage	300 V AC
Test voltage	2000 V AC
Temperature range (fixed)	-40...+80 °C
Temperature range (mobile)	-5...+80 °C
Bend radius (moving)	15× outer Ø

Commercial data

country of origin	DE
customs tariff number	85444290
EAN	4048879387163
eClass	27279218
Packaging unit	1.000