

**M12 male 0° / M12 female 0° A-cod. shielded**

PUR 4x0.34 shielded gy 0.4m

Male straight – female straight  
M12 – M12, 4-pole  
shielded

Plastic housings with good resistance against chemicals and oils.

The resistance to aggressive media should be individually tested for your application. Further details on request.

Further cable lengths on request.

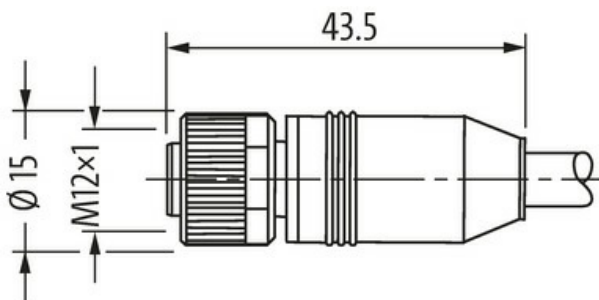
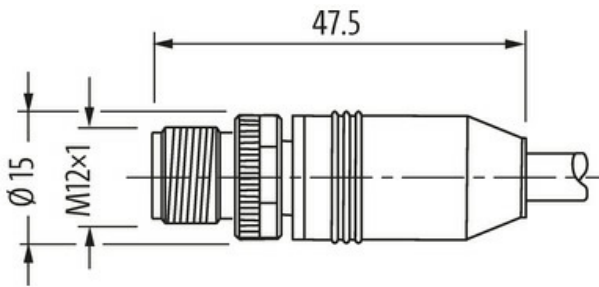
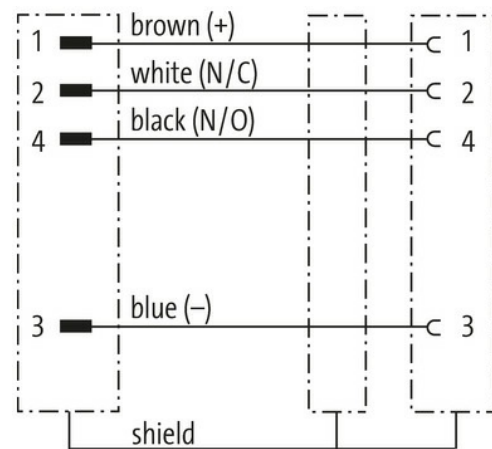
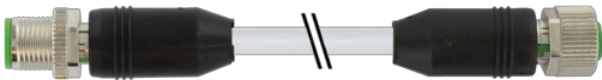
**[Link to Product](#)****Illustration**

Product may differ from Image

Male

Female

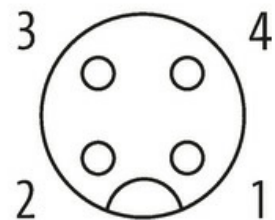
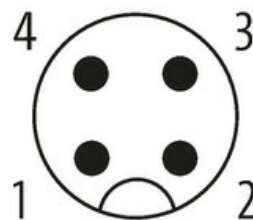

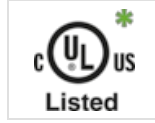

\* only for products with UL/CSA approved cable

| Form                               |  |
|------------------------------------|--|
| Form                               | 40501  |
| Technical Data                     |  |
| Operating voltage                  | max. 60 V AC/DC  |
| Operating voltage (only UL listed) | max. 30 V AC/DC  |
| Operating current per contact      | max. 4 A   |
| Locking of ports                   | Screw thread (M12×1 mm) recommended torque 0.6 Nm, self-securing |
| Compression gland                  | M12 (SW13)   |
| Protection                         | IP65 and IP67 when plugged and screwed down (EN 60529)           |
| Locking material                   | Zinc die casting, matte nickel plated                            |
| General data                       |  |
| Standards                          | DIN EN 61076-2-101 (M12)   |
| Temperature range                  | -25...+85 °C, depending on cable quality                         |
| Cables                             |  |
| No./diameter of wires              | 4× 0.34 mm <sup>2</sup>  |
| Wire isolation                     | PVC (br, wh, bl, bk)   |
| Outer Ø                            | 5.9 mm ±5%   |
| Cable number                       | 331  |
| Approval (cable)                   | CE conform   |
| Shield                             | yes  |
| Color (jacket)                     | gray   |
| Jacket Color                       | gray   |
| Temperature range (fixed)          | -30...+80 °C   |
| Temperature range (mobile)         | -5...+70 °C  |
| Bend radius (fixed)                | 10× outer Ø  |
| Bend radius (moving)               | 15× outer Ø  |
| Material (jacket)                  | PUR/PVC  |
| Commercial data                    |  |
| country of origin                  | DE   |
| customs tariff number              | 85444290   |
| EAN                                | 4048879642378  |
| eClass                             | 27279218   |
| Packaging unit                     | 1.000  |