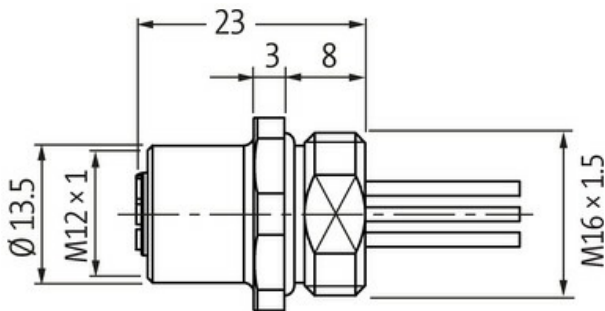
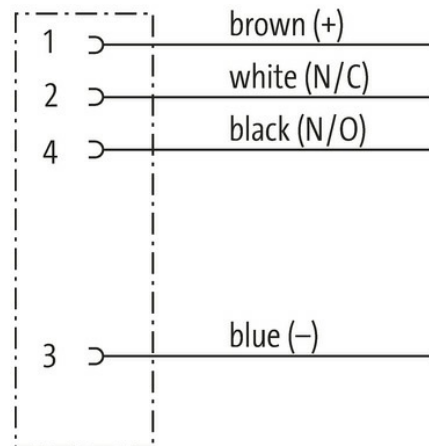
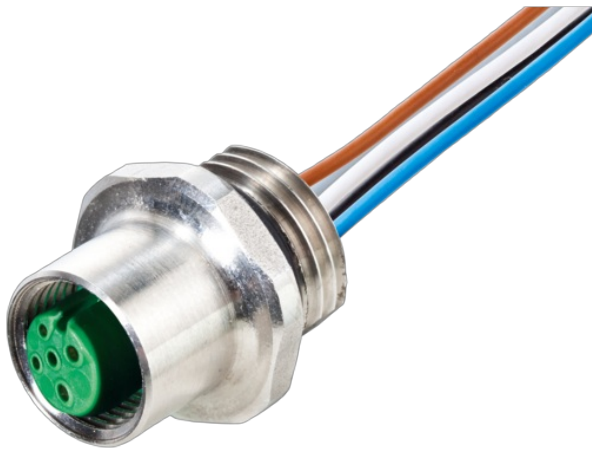
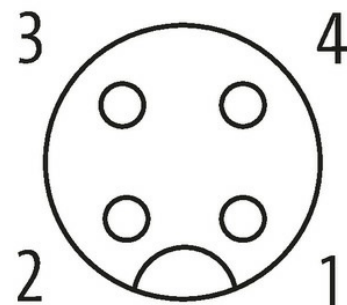

M12 female recept. A-cod. front F&B

PP-wires 4x0.34 0.2m

F&B
 Flange female
 M12, 4-pole
 Front mounting
 with multi-strand wire
 Stainless steel 1.4404 (V4A)

[Link to Product](#)**Illustration****Female**

Product may differ from Image

**Form**

Form 13541

Technical Data

Operating voltage max. 250 V AC/DC

Rated surge voltage	2.5 kV
Operating current per contact	max. 4 A
No. of poles	4
Material group	IEC 60664-1, category I
Coding	A-coded
LED display	no
Locking of ports	Screw thread (M12×1 mm) recommended torque 0.6 Nm, self-securing
Compression gland	M12 (SW14)
Protection NEMA	3, 4, 6P (UL 50E)
Material	Stainless steel 1.4404 (V4A)
Locking material	Stainless steel 1.4404 (V4A)
suitable for corrugated tube (internal Ø)	without

General data

Standards	DIN EN 61076-2-101 (M12)
Material (contact)	Copper alloy
Material (contact surface)	Au
Material (gasket)	EPDM
Pollution Degree	3
Temperature range	-25...+85 °C

Cables

No./diameter of wires	4× 0.34 mm ²
Wire isolation	PUR
Outer Ø	1.3 mm ±5%
Cable number	971
Temperature range (fixed)	-40...+90 °C
Temperature range (mobile)	-25...+90 °C
Bend radius (fixed)	5× outer Ø

Commercial data

country of origin	DE
customs tariff number	85444290
EAN	4048879363655
eClass	27279218
Packaging unit	1.000