

M12 fem. recept. D-cod. rear/RJ45 male 0° shielded

PUR 1x4xAWG22 shielded gn UL/CSA 5m

Ethernet CAT5

Plastic housings with good resistance against chemicals and oils.

Flange female straight – male straight

M12 – RJ45, 4-pole

D-coded

shielded

8-pole partly used

Rear mounting

Transmission properties with channel transmission up to 100 m

Further cable lengths on request.

[Link to Product](#)**Illustration**

Female



Male

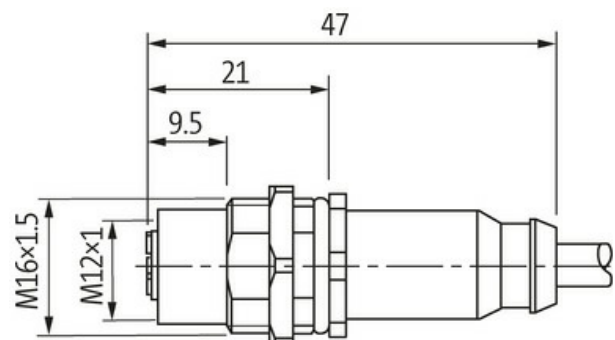



Product may differ from Image



* only for products with UL/CSA approved cable

Form	
Form	44851
Technical Data	
Operating voltage	max. 60 V DC
Operating voltage (only UL listed)	max. 30 V DC
Rated surge voltage	1.0 kV
Operating current per contact	max. 1.5 A (20 °C)
Transfer parameters	CAT5, Class D (ISO/IEC 11801:2002), (EN 50173-1)
Transfer rate	up to 100 Mbit/s full duplex
Material group	IEC 60664-1, category I
Coding	M12, D-coded
Locking of ports	Hexagonal nut (M16×1.5 mm)
Compression gland	M16 (SW19)
Protection	IP67 (M12) - IP20 (RJ45)
Protection NEMA	3, 4, 6P (UL 50E) (M12)
Material	PUR
Locking material	Brass, nickel plated
suitable for corrugated tube (internal Ø)	10 mm
General data	
Standards	DIN EN 61076-2-101 (M12)
Pollution Degree	3
Temperature range	-25...+85 °C, depending on cable quality
Cables	
Cable identification	794
Approval (cable)	cURus (AWM-Style 20549/10578), CE-conform
Cable weight [g/m]	75,87 g
Material (wire)	Cu wire, bare
Resistor (core)	max. 55 Ω/km (20 °C)
Construction (core)	7× 0.254 mm
Diameter (core)	1× 4× AWG22/7
AWG	similar to AWG 22
Material (wire isolation)	PE
Wire-Ø incl. isolation	1.55 mm ±5%
Color/numbering of wires	wh, ye, bl, or
Shield	yes

The information in this brochure has been compiled with the utmost care.

Liability for the correctness completeness and topicality of the information is restricted to gross negligence. Version: 03/22

optical shield cover	min. 85%
Material (jacket)	PUR
Outer-Ø (jacket)	6.7 mm ±5%
Color (jacket)	green
chemical resistance	Oil resistance according to IEC 60811-2-1, ASTM IRM 901, ICEA S-82-552 Std.
thermal resistance	flame-retardant according to UL 1581 section 1090, section 1100 (FT2), IEC 60332-1-2 Std.
Nominal voltage	300 V
Temperature range (fixed)	-40...+80 °C
Temperature range (mobile)	-30...+70 °C
Bend radius (fixed)	6× outer Ø
Bend radius (moving)	12× outer Ø

Commercial data

country of origin	DE
customs tariff number	85444290
EAN	4048879559119
eClass	27061801
Packaging unit	1.000