

**M12 female 90° field-wireable**5-pole max. 0.75mm<sup>2</sup> 6-8mm

Female 90°

M12, 5-pole

Screw terminal

Connection cross section

max. 0.75 mm<sup>2</sup>

Please use wire end ferrule.

The resistance to aggressive media should be individually tested for your application. Further details on request.

[Link to Product](#)**Illustration**

Female

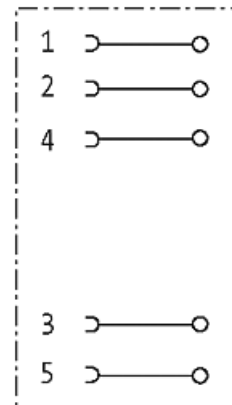
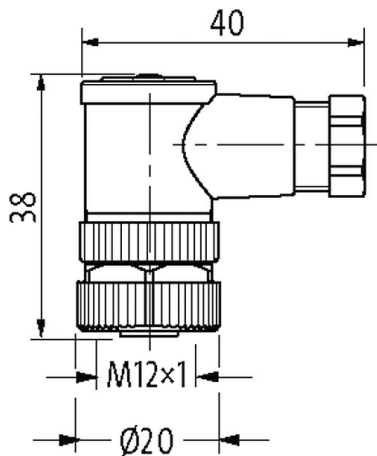
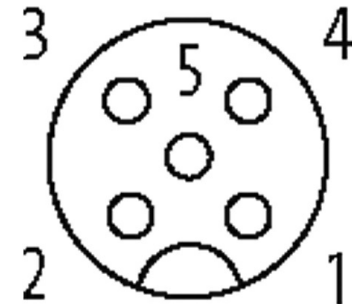

Product may differ from Image

**Technical Data**

Operating voltage	max. 60 V AC/DC
Rated surge voltage	0.8 kV
Operating current per contact	max. 4 A; max. 3 A (UL-Recognized)

No. of poles	5
Material group	IEC 60664-1, category III
Coding	A-coded
LED display	no
Connection cross section	max. 0.75 mm <sup>2</sup>
Sealing range (cable Ø)	6...8 mm
Locking of ports	Screw thread (M12×1 mm) recommended torque 0.6 Nm, self-securing
Compression gland	pluggable, screw locking / M12 (A/F18) / zinc-pressure die casting, surface Ni
Protection	IP67 mounted and tightened
Housing	PA

**General data**

Standards	DIN EN 61076-2-101 (M12)
Material (contact)	Copper alloy
Material (contact surface)	Copper alloy
Material (gasket)	FKM
Pollution Degree	3
Temperature range	-40...+85 °C

**Commercial data**

country of origin	DE
customs tariff number	85366990
EAN	4048879848626
eClass	27279221
Packaging unit	10