

VALVE PLUG SUPPRESSOR FORM A - 18MM

With LED, 48VAC/DC/50VA/W

48 V AC/DC

LED

Remove plug gasket when fitting adapter. Other LED colors on request.

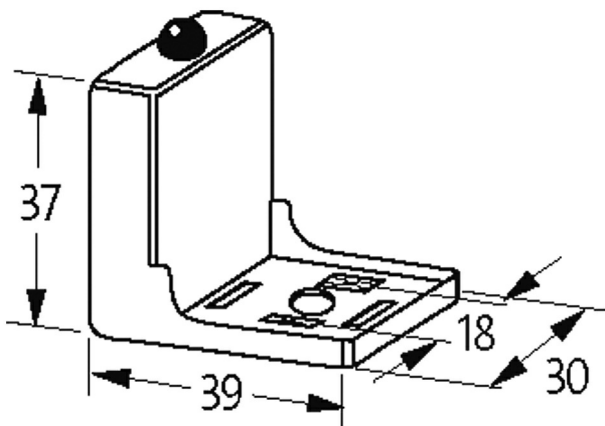
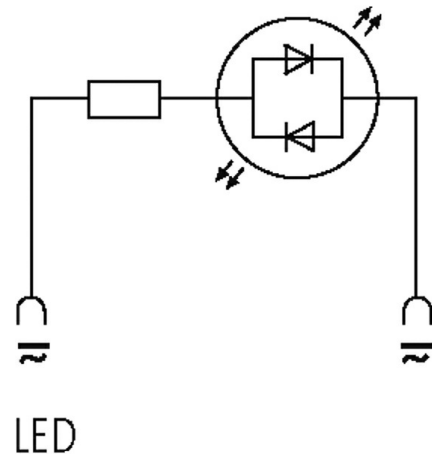
[Link to Product](#)**Illustration**

Product may differ from Image

Technical Data

LED display	(yellow opac)
Input voltage	30...53 V AC/DC
max. power (W)	max. 50 W (VA)

General data

Material (contact)	Silvered bronze
Temperature range	-20...+60 °C
Housing	Polyamide black, flame retardant, temperature resistance up to 130 °C
Dimensions H×W×D	37×39×30 mm

Commercial data

country of origin	CZ
customs tariff number	85363010

EAN	4048879012287
eClass	27371013
Packaging unit	1.000