

RJ45 male 45° down / RJ45 male 45° right shielded

PUR 1x4xAWG22 shielded gn UL/CSA 20m

Ethernet CAT5

Male 45° down – male 45° right

RJ45 – RJ45, 4-pole
shielded

Further cable lengths on request.

Plastic housings with good resistance against chemicals and oils.

The resistance to aggressive media should be individually tested for your application. Further details on request.

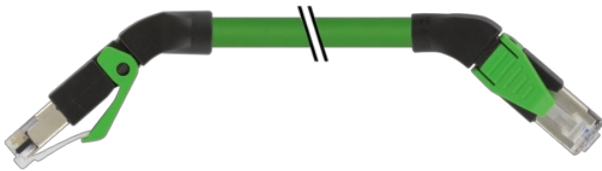
[Link to Product](#)**Illustration**

Male

6 321



Male

6 321

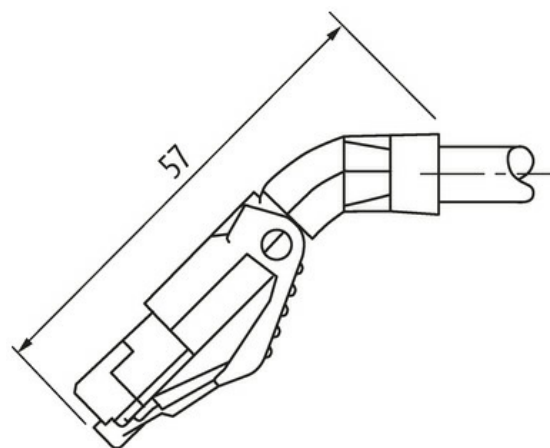



Product may differ from Image



* only for products with UL/CSA approved cable

Form	
Form	74521
Technical Data	
Operating voltage	max. 60 V DC
Operating voltage (only UL listed)	max. 30 V DC
Rated surge voltage	1.0 kV
Operating current per contact	max. 1.5 A (20 °C)
Transfer parameters	CAT5, Class D (ISO/IEC 11801:2002), (EN 50173-1)
Transfer rate	up to 100 Mbit/s full duplex
Material group	IEC 60664-1, category I
Protection	IP20 inserted and tightened (EN 60529)
Material	PUR
Locking material	PA
suitable for corrugated tube (internal Ø)	without
General data	
Pollution Degree	3
Temperature range	-25...+85 °C, depending on cable quality
Cables	
Cable identification	794
Approval (cable)	cURus (AWM-Style 20549/10578), CE-conform
Cable weight [g/m]	75,87 g
Material (wire)	Cu wire, bare
Resistor (core)	max. 55 Ω/km (20 °C)
Construction (core)	7 × 0.254 mm
Diameter (core)	1 × 4 × AWG22/7
AWG	similar to AWG 22
Material (wire isolation)	PE
Wire-Ø incl. isolation	1.55 mm ±5%

Color/numbering of wires	wh, ye, bl, or
Shield	yes
optical shield cover	min. 85%
Material (jacket)	PUR
Outer-Ø (jacket)	6.7 mm ±5%
Color (jacket)	green
chemical resistance	Oil resistance according to IEC 60811-2-1, ASTM IRM 901, ICEA S-82-552 Std.
thermal resistance	flame-retardant according to UL 1581 section 1090, section 1100 (FT2), IEC 60332-1-2 Std.
Nominal voltage	300 V
Temperature range (fixed)	-40...+80 °C
Temperature range (mobile)	-30...+70 °C
Bend radius (fixed)	6× outer Ø
Bend radius (moving)	12× outer Ø

Commercial data

country of origin	DE
customs tariff number	85444210
EAN	4048879824422
eClass	27061801
Packaging unit	1.000