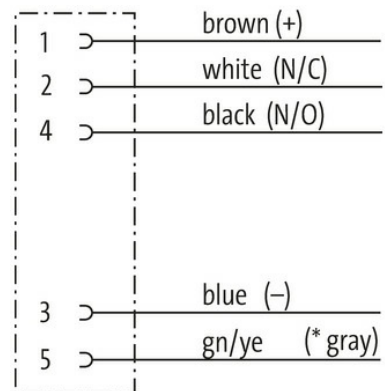

M12 female recept. A-cod. front V2A

PP-wires 5x0.34 1m

Flange female
M12, 5-pole
Front mounting
with multi-strand wire
Stainless steel 1.4305 (V2A)

[Link to Product](#)**Illustration**

(* for cable type 902, 972)

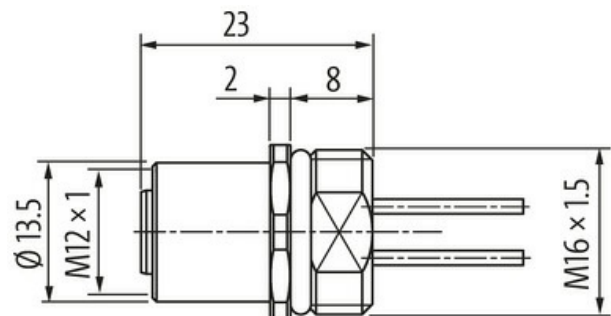
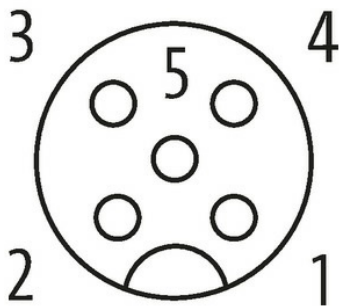
Female

Product may differ from Image

**Form**

Form 13561

Technical Data

Operating voltage	max. 125 V AC/DC
Rated surge voltage	1.5 kV
Operating current per contact	max. 4 A

No. of poles	5
Material group	IEC 60664-1, category I
Coding	A-coded
LED display	no
Locking of ports	Screw thread (M12×1 mm) recommended torque 0.6 Nm, self-securing
Compression gland	M12 (SW14)
Protection	IP67 inserted and tightened (EN 60529)
Protection NEMA	3, 4, 6P (UL 50E)
Material	Stainless steel 1.4305 (V2A)
Locking material	Stainless steel 1.4305 (V2A)
suitable for corrugated tube (internal Ø)	without

General data

Standards	DIN EN 61076-2-101 (M12)
Mounting method	inserted, tightened
Material (contact)	Copper alloy
Material (contact surface)	Au
Material (gasket)	FKM
Pollution Degree	3
Temperature range	-25...+85 °C

Cables

No./diameter of wires	5× 0.34 mm ²
Wire isolation	PUR (br, wh, bl, bk, gr)
Outer Ø	1.3 mm ±5%
Cable number	972
Material (wire)	Cu wire, tin plated
Resistor (core)	max. 58 Ω/km (20 °C)
Nominal voltage	300 V AC
Test voltage	1500 V AC
Temperature range (fixed)	-40...+90 °C
Temperature range (mobile)	-25...+90 °C

Commercial data

country of origin	DE
customs tariff number	85444290
EAN	4048879333146
eClass	27279220
Packaging unit	1.000