

MQ15-X-Power female 90°right shielded with cable

PUR 4x1,5 or UL/CSA+drag chain 2,0m

Female 90°
MQ15, 4-pole
shielded

without cable sleeves

Plastic housings with good resistance against chemicals and oils.

The resistance to aggressive media should be individually tested for your application. Further details on request.

Further cable lengths on request.

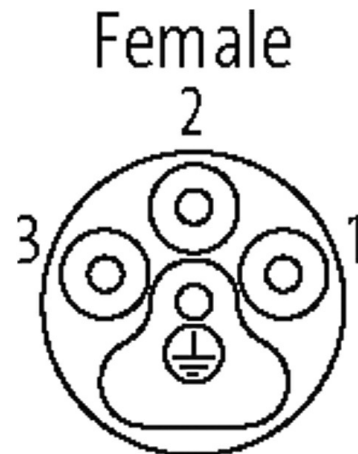
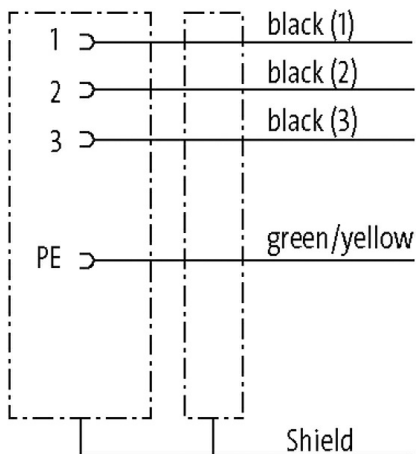
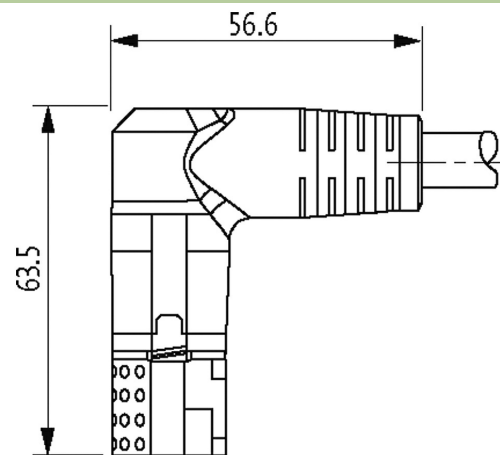
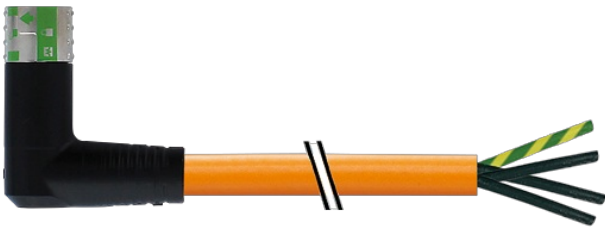
[Link to Product](#)**Illustration**

Product may differ from Image

Form

Form P8031

Technical Data

Operating voltage max. 600 V AC

Rated surge voltage 4.0 kV

Operating current per contact max. 13 A

No. of poles 4

Configuration fully used

LED display	no
Locking of ports	Quick connection, 1/4 turn
Protection	IP67 inserted and tightened (EN 60529)
Material	Flame retardant plastic acc. to (UL 94)
Mating cycles	≥ 500
Material group	IEC 60664-1, category I

General data

Mounting method	inserted, tightened
Material (contact carrier)	PA
Material (contact)	Copper alloy
Material (contact surface)	Ag
Stripping length (jacket)	30 mm
Pollution Degree	3
Temperature range	-25...+80 °C, depending on cable quality

Cables

Cable number	P12
No./diameter of wires	4× 1.5 mm ²
Wire isolation	TPM (bk num, gnye)
C-track properties	5 Mio.
Jacket Color	orange
Material (jacket)	PUR (UL)
Outer Ø	8.0 mm ±5%
Bend radius (moving)	10× outer Ø
Temperature range (fixed)	-40...+80 °C
Temperature range (mobile)	-20...+60 °C
Cable identification	P12
Cable weight [g/m]	128,7
Material (wire)	Cu wire, bare
Diameter (core)	4× 1.5 mm ²
Color/numbering of wires	bk numbered, gnye longitudinally striped
Shield	yes
Material (jacket)	PUR
Outer-Ø (jacket)	8.0 mm ±5%
Color (jacket)	orange
thermal resistance	flame retardant
Nominal voltage	1000 V AC
Test voltage	4000 V
Temperature range (fixed)	-40...+80 °C
Temperature range (mobile)	-20...+60 °C
Bend radius (fixed)	10× outer Ø
Bend radius (moving)	10× outer Ø
Traversing distance (C-track)	max. 5 m (horizontal)
Travel speed (C-track)	max. 3.3 m/s
Acceleration (C-track)	max. 5 m/s ²
Torsion stress	±15°/m

Commercial data

country of origin	DE
customs tariff number	85444290
EAN	4048879701310
eClass	27279221
Packaging unit	1