

RJ45 PushPull male 0°/RJ45 Push Pull male 45° AIDA

PUR 1x4xAWG22 shielded gn UL/CSA+drag ch. 0.6m

Male straight – male 90°

RJ45PP – RJ45PP

4-pole

shielded

Further cable lengths on request.

Plastic housings with good resistance against chemicals and oils.

The resistance to aggressive media should be individually tested for your application. Further details on request.

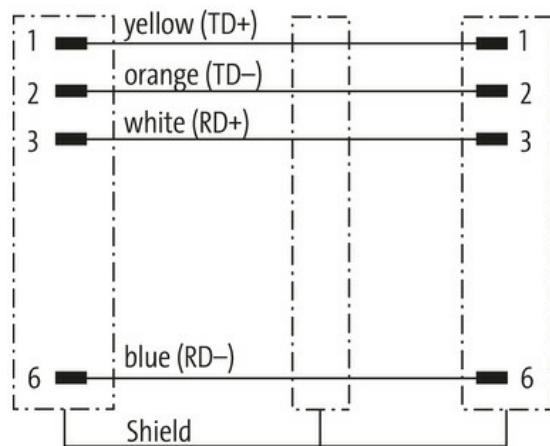
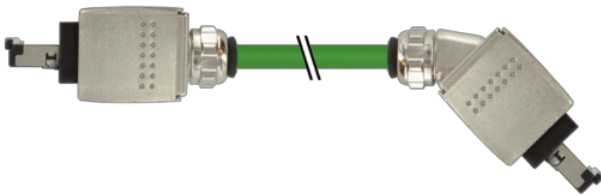
[Link to Product](#)**Illustration**

Male



Male

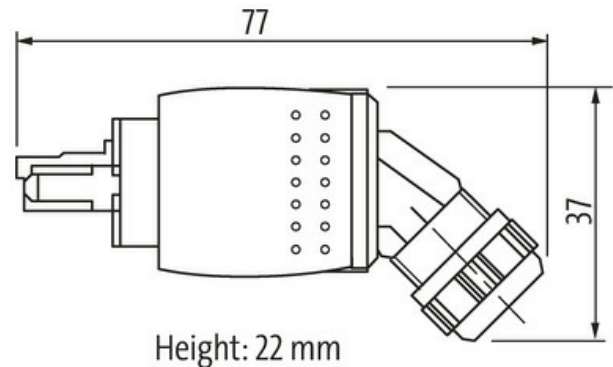
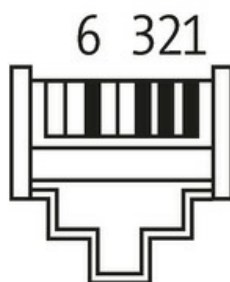

Product may differ from Image



* only for products with UL/CSA approved cable

Form

Form 74661

Technical Data

Operating voltage max. 60 V DC

Operating voltage (only UL listed) max. 30 V DC

Rated surge voltage	1.0 kV
Operating current per contact	max. 1.76 A
Transfer parameters	CAT5, Class D (ISO/IEC 11801:2002), (EN 50173-1)
Transfer rate	up to 100 Mbit/s full duplex
Material group	IEC 60664-1, category I
Locking of ports	Push Pull
Protection	IP65 and IP67 when plugged and screwed down (EN 60529)
Locking material	Zinc die casting, matte nickel plated
suitable for corrugated tube (internal Ø)	without

General data

Pollution Degree	3
Temperature range	-25...+85 °C, depending on cable quality

Cables

Cable identification	796
Approval (cable)	cURus (AWM-Style 20549/11602), CE-conform
Cable weight [g/m]	69,3 g
Material (wire)	Cu wire, bare
Resistor (core)	max. 55 Ω/km (20 °C)
Construction (core)	7× 0.254 mm
Diameter (core)	1× 4× AWG22/7
Material (wire isolation)	PE
Wire-Ø incl. isolation	1.4 mm ±5%
Color/numbering of wires	wh, ye, bl, or
Shield	yes
optical shield cover	min. 85%
Material (jacket)	PUR
Material property (jacket)	CFC-, halogen-, cadmium-, silicone- and lead-free, matt, low-adhesion, machine easy to process, abrasion-resistant, hydrolysis and microbial resistant
Outer-Ø (jacket)	6.7 mm ±5%
Color (jacket)	green
chemical resistance	Oil resistance according to IEC 60811-2-1, ASTM IRM 901, ICEA S-82-552 Std.
thermal resistance	flame-retardant according to UL 1581 section 1090, section 1100 (FT2), IEC 60332-1-2 Std.
Nominal voltage	300 V
Test voltage	2000 V AC (test duration 1 min)
Temperature range (fixed)	-40...+80 °C
Temperature range (mobile)	-30...+70 °C
Bend radius (fixed)	5× outer Ø
Bend radius (moving)	12× outer Ø
No. of bending cycles (C-track)	max. 3 Mio. (25 °C)
Travel speed (C-track)	max. 3.3 m/s
Acceleration (C-track)	max. 2 m/s ²

Commercial data

country of origin	DE
customs tariff number	85444210
EAN	4048879375320
eClass	27061801
Packaging unit	1.000