

M12 female 0° D-cod. / RJ45 male 0° shielded

PUR 1x4xAWG22 shielded gn UL/CSA 5m

Ethernet CAT5

Female straight – male straight

M12 – RJ45, 4-pole

D-coded

shielded

Transmission properties with channel transmission up to 100 m

Further cable lengths on request.

Plastic housings with good resistance against chemicals and oils.

The resistance to aggressive media should be individually tested for your application. Further details on request.

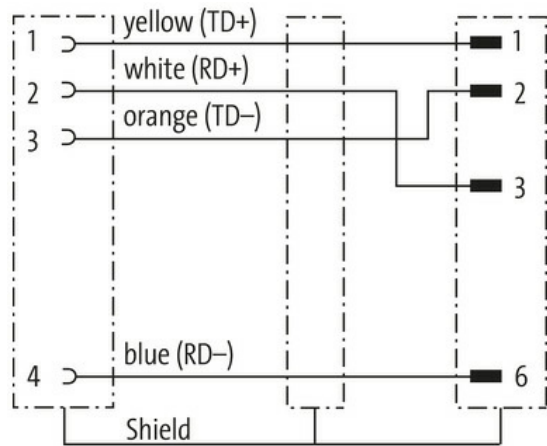
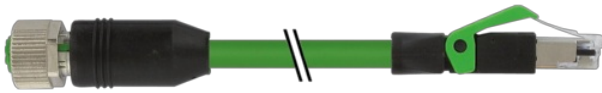
[Link to Product](#)**Illustration**

Female



Male

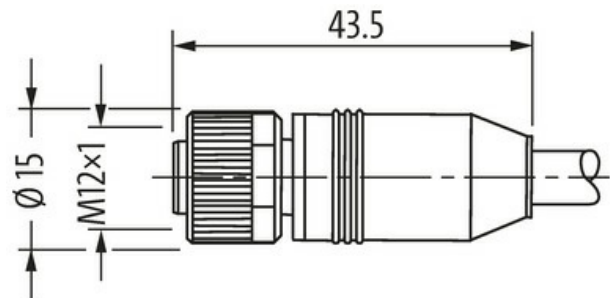



Product may differ from Image



* only for products with UL/CSA approved cable

Form	
Form	44621
Technical Data	
Operating voltage	max. 60 V DC
Operating voltage (only UL listed)	30 V DC
Rated surge voltage	1.0 kV
Operating current per contact	max. 1.5 A
Transfer parameters	CAT5, Class D (ISO/IEC 11801:2002), (EN 50173-1)
Transfer rate	up to 100 Mbit/s full duplex
Material group	IEC 60664-1, category I
Coding	D-coded
LED display	no
Locking of ports	Screw thread (M12×1 mm) recommended torque 0.6 Nm, self-securing
Compression gland	M12 (SW13)
Protection	IP67 (M12) - IP20 (RJ45)
Material	PUR
Locking material	Zinc die casting, matte nickel plated
suitable for corrugated tube (internal Ø)	without
General data	
Standards	DIN EN 61076-2-101 (M12)
Mounting method	inserted, tightened
Material (gasket)	FKM
Pollution Degree	3
Temperature range	-25...+85 °C, depending on cable quality
Cables	
Cable identification	794
Approval (cable)	cURus (AWM-Style 20549/10578), CE-conform
Cable weight [g/m]	75,87 g
Material (wire)	Cu wire, bare
Resistor (core)	max. 55 Ω/km (20 °C)
Construction (core)	7 × 0.254 mm
Diameter (core)	1 × 4 × AWG22/7
AWG	similar to AWG 22
Material (wire isolation)	PE
Wire-Ø incl. isolation	1.55 mm ±5%

The information in this brochure has been compiled with the utmost care.

Liability for the correctness completeness and topicality of the information is restricted to gross negligence. Version: 03/22

Color/numbering of wires	wh, ye, bl, or
Shield	yes
optical shield cover	min. 85%
Material (jacket)	PUR
Outer-Ø (jacket)	6.7 mm ±5%
Color (jacket)	green
chemical resistance	Oil resistance according to IEC 60811-2-1, ASTM IRM 901, ICEA S-82-552 Std.
thermal resistance	flame-retardant according to UL 1581 section 1090, section 1100 (FT2), IEC 60332-1-2 Std.
Nominal voltage	300 V
Temperature range (fixed)	-40...+80 °C
Temperature range (mobile)	-30...+70 °C
Bend radius (fixed)	6× outer Ø
Bend radius (moving)	12× outer Ø

Commercial data

country of origin	DE
customs tariff number	85444290
EAN	4048879664646
eClass	27061801
Packaging unit	1.000