

**M8 male 90° A-cod. / MSUD valve plug BI-11mm**

PVC 3x0.34 bk UL/CSA 0.3m

**MSUD**

Plastic housings with good resistance against chemicals and oils.

Form BI (11 mm)

Male M8

90°

24 V AC  $\pm 20\%$  / DC  $\pm 25\%$ 

3-pole

Z-Diode + LED

Art-No. 7005 - M8 Lite - (plastic hexagonal screw) on request

Further cable lengths on request.

[Link to Product](#)**Illustration**

Height: 30 mm

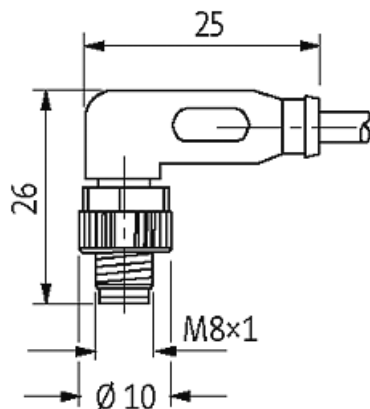



Product may differ from Image

**Form**

Form 88801

**Technical Data**

Operating voltage	24 V AC $\pm 20\%$ / DC $\pm 25\%$
Rated surge voltage	0.8 kV
Operating current per contact	max. 4 A
No. of poles	3
Current consumption	15 mA
Material group	IEC 60664-1, category I
Switch off peak	max. 55 V
LED display	yellow
Locking of ports	M3/M8 (recommended torque 0.4 Nm)
Compression gland	M8 (SW9)
Protection	IP65 and IP67 when plugged and screwed down (EN 60529)
Material	MSUD (PBT); M8 (PUR)
Locking material	Zinc die casting, matte nickel plated
suitable for corrugated tube (internal $\varnothing$ )	6.5 mm
Housing	Black plastic (gray on request)
Additional suppressor	Diode/Z-Diode

**General data**

Standards	DIN EN 61076-2-104 (M8)
Mounting method	inserted, tightened
Material (contact)	Copper alloy
Material (contact surface)	MSUD (Ag); M8 (Au)
Material (gasket)	PUR
Pollution Degree	3
Temperature range	-25...+85 °C, depending on cable quality

**Cables**

No./diameter of wires	3x 0.34 mm <sup>2</sup>
Wire isolation	PVC (br, bl, bk)
Material (jacket)	PVC (UL/CSA)
Outer $\varnothing$	4.6 mm $\pm 5\%$
Bend radius (moving)	10x outer $\varnothing$
Temperature range (fixed)	-30...+80 °C
Temperature range (mobile)	-5...+80 °C
Cable identification	613
Cable Type	1 (PVC)

Approval (cable)	UL (AWM-Style 2464/1731), CSA
Cable weight [g/m]	34,10
Material (wire)	Cu wire, bare
Resistor (core)	max. 60 $\Omega$ /km (20 °C)
Single wire $\varnothing$ (core)	0.15 mm
Construction (core)	19x 0.15 mm (multi-strand wire class 5)
AWG	similar to AWG 22
Material (wire isolation)	PVC
Material property (wire isolation)	CFC-, cadmium-, silicone- and lead-free
Shore hardness (wire isolation)	45 $\pm$ 5 D
Wire- $\varnothing$ incl. isolation	1.25 mm $\pm$ 5%
Color/numbering of wires	br, bk, bl
Stranding combination	3 wires twisted
Shield	no
Material (jacket)	PVC
Material property (jacket)	CFC-, cadmium-, silicone- and lead-free
Shore hardness (jacket)	85 $\pm$ 5 A
Outer- $\varnothing$ (jacket)	4.6 mm $\pm$ 5%
Color (jacket)	black
chemical resistance	good resistance to oil, gasoline and chemicals
thermal resistance	flame retardant UL 1581 VW1 / CSA FT1
Nominal voltage	UL 300 V AC
Test voltage	2000 V AC
Current load capacity	to DIN VDE 0298-4
Temperature range (fixed)	-30...+80 °C
Temperature range (mobile)	-5...+80 °C
Bend radius (fixed)	5x outer $\varnothing$
Bend radius (moving)	10x outer $\varnothing$
Jacket Color	black

#### Commercial data

country of origin	CZ
customs tariff number	85444290
EAN	4048879116336
eClass	27279218
Packaging unit	1