

M12 Steel male 0° / M12 Steel female 90° A-cod.

TPE-S 4x0.34 gy 1.5m

F&B-Steel

Male straight – female 90°

M12 – M12, 4-pole

Further cable lengths on request.

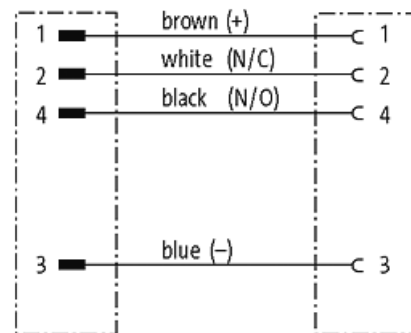
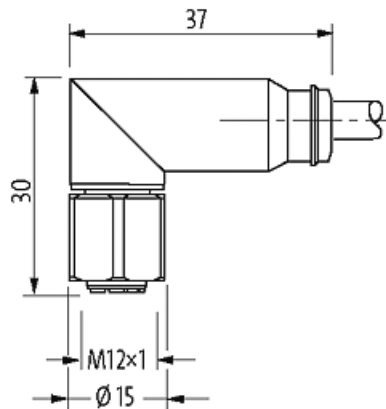
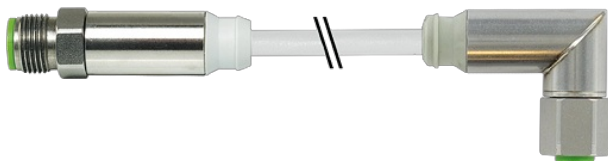
[Link to Product](#)**Illustration**

Male

Female

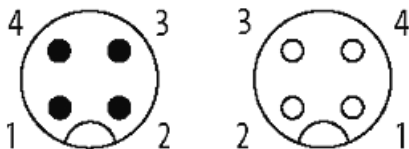

Product may differ from Image



* only for products with UL/CSA approved cable

Form

Form 40121

Technical Data

Operating voltage	max. 32 V AC/DC
Operating current per contact	max. 4 A
Locking of ports	Screw thread (M12x1 mm) recommended torque 0.6 Nm, self-securing
Protection	IP68, IP69K inserted and tightened (EN 60529)

