

MQ15-X- Power male receptacle front mount

PVC 6x1,5 UL/CSA 0,25m

Flange male

MQ15, 6-pole

with multi-strand wire

Front mounting

Plastic housings with good resistance against chemicals and oils.

The resistance to aggressive media should be individually tested for your application. Further details on request.

Further cable lengths on request.

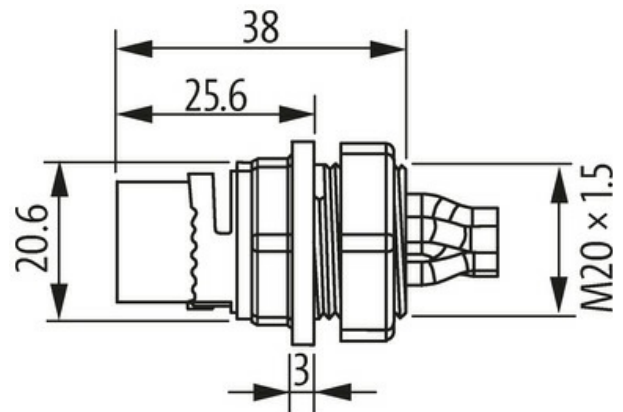
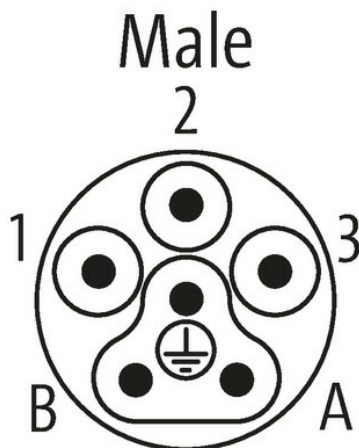
[Link to Product](#)**Illustration**

Product may differ from Image

Form

Form P8181

Technical Data

Operating voltage	max. 600 V AC (Power); max. 63 V AC/DC (Signal)
Rated surge voltage	2.5 kV
Operating current per contact	max. 13 A (Power); max. 10 A (Signal)
No. of poles	6
Material group	IEC 60664-1, category I

Mating cycles	≥ 500
LED display	no
Locking of ports	Quick connection, 1/4 turn
Protection	IP67 inserted and tightened (EN 60529)
Protection NEMA	3, 4, 6P (UL 50E)
Material	Brass, nickel plated
Configuration	fully used

General data

Mounting method	inserted, tightened
Material (contact)	Copper alloy
Material (contact surface)	Ag
Pollution Degree	3
Temperature range	-40...+70 °C, depending on cable quality
Material (contact carrier)	PA

Cables

Cable identification	P83
Diameter (core)	6× 1.5 mm ²
AWG	similar to AWG 16
Material (wire isolation)	PVC
Wire-Ø incl. isolation	3.1 mm ±5%
Color/numbering of wires	PVC (bk, bl, num, gnye)
chemical resistance	good resistance to oil, gasoline and chemicals
thermal resistance	flame retardant
Test voltage	2500 V AC
Bend radius (fixed)	5× outer Ø

Commercial data

country of origin	DE
customs tariff number	85444290
EAN	4048879830201
eClass	27279220
Packaging unit	1.000