

MOSA M12 FEMALE 90° FIELD-WIREABLE (IDC)4-pol. 0.25...0.5mm²

Female 90°

M12, 4-pole

IDC terminals

Connection cross section: 0.25...0.5 mm²

Art-No. 7005 - M12 Lite - (plastic hexagonal screw) on request

The resistance to aggressive media should be individually tested for your application. Further details on request.

[Link to Product](#)**Illustration**

Female

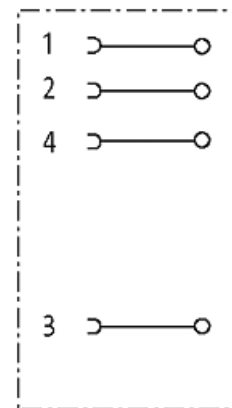
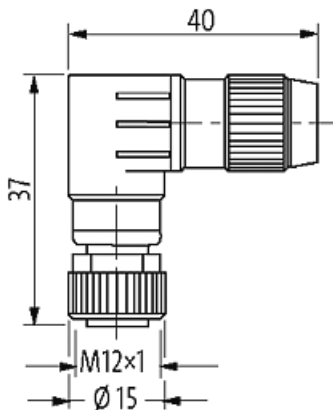
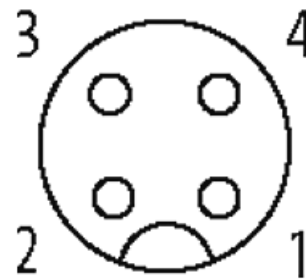

Product may differ from Image

Form

Form 12681

Technical Data

Operating voltage	max. 32 V AC/DC
Operating current per contact	max. 4 A
Connection cross section	0.25...0.5 mm ² (conductor diameter min. 0.1 mm)
Sealing range (cable Ø)	4...5.1 mm
Wire isolation	PVC, PP, TPE
Outer wire Ø	1.2...1.6 mm
Locking of ports	Screw thread (M12×1 mm) recommended torque 0.6 Nm, self-securing
Protection	IP67 inserted and tightened (EN 60529)
Reconnection (cable)	10

General data

Temperature range	-25...+85 °C
Dimensions H×W×D	37×40×15 mm

Commercial data

country of origin	DE
customs tariff number	85366990
EAN	4048879201681
eClass	27279221
Packaging unit	1