

M8 male 0° snap-in/M12 fem. 90° A-cod.screw-in LED

PVC 3x0.25 gy UL/CSA 1.5m

Male straight – female 90°

M8 (Snap In) – M12, 3-pole

2x LED (PNP), (NPN) on request

Art-No. 7005 - M12 Lite - (plastic hexagonal screw) on request

Further cable lengths on request.

Plastic housings with good resistance against chemicals and oils.

The resistance to aggressive media should be individually tested for your application. Further details on request.

Link to Product

Illustration

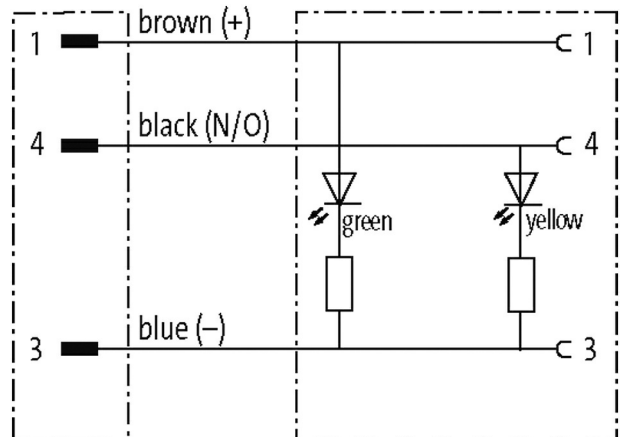
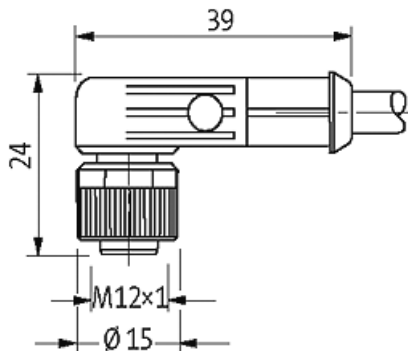
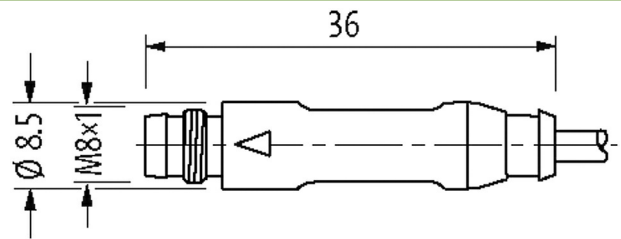

Male

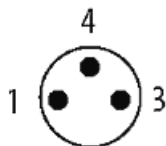

Female



Product may differ from Image



* only for products with UL/CSA approved cable

Form

Form

88401

Technical Data	
Operating voltage	24 V DC \pm 25%
Operating voltage (only UL listed)	max. 30 V DC
Rated surge voltage	0.8 kV
Operating current per contact	max. 4 A
Material group	IEC 60664-1, category I
Coding	M12, A-coded
LED display	yellow/green
Locking of ports	Screw thread (M12 \times 1 mm) recommended torque 0.6 Nm, self-securing, M8 (Snap In)
Compression gland	M12 (SW13)
Protection	IP65, IP66K, IP67 (M12) - IP65 (M8)
Locking material	Zinc die casting, matte nickel plated (M12)
Material	PUR
suitable for corrugated tube (internal \varnothing)	M12 (10 mm); M8 (6.5 mm)
General data	
Standards	DIN EN 61076-2-101 (M12), DIN EN 61076-2-104 (M8)
Pollution Degree	3
Temperature range	-25...+85 °C, depending on cable quality
Cables	
Cable identification	210
Cable Type	1 (PVC)
Approval (cable)	UL (AWM-Style 2464/1731), CSA
Cable weight [g/m]	29,37
Material (wire)	Cu wire, bare
Resistor (core)	max. 79 Ω /km (20 °C)
Single wire \varnothing (core)	0.15 mm
Construction (core)	14 \times 0.15 mm (multi-strand wire class 5)
Diameter (core)	3 \times 0.25 mm ²
AWG	similar to AWG 24
Material (wire isolation)	PVC
Material property (wire isolation)	CFC-, cadmium-, silicone- and lead-free
Shore hardness (wire isolation)	45 \pm 5 D
Wire- \varnothing incl. isolation	1.25 mm \pm 5%
Color/numbering of wires	br, bk, bl
Stranding combination	3 wires twisted
Shield	no
Material (jacket)	PVC
Material property (jacket)	CFC-, cadmium-, silicone- and lead-free
Shore hardness (jacket)	85 \pm 5 A
Outer- \varnothing (jacket)	4.5 mm \pm 5%
Color (jacket)	gray
chemical resistance	good resistance to oil, gasoline and chemicals
thermal resistance	flame retardant UL 1581 VW1 / CSA FT1
Nominal voltage	UL 300 V AC
Test voltage	2000 V AC
Current load capacity	to DIN VDE 0298-4
Temperature range (fixed)	-30...+80 °C
Temperature range (mobile)	-5...+80 °C
Bend radius (fixed)	5 \times outer \varnothing
Bend radius (moving)	10 \times outer \varnothing
No./diameter of wires	3 \times 0.25 mm ²
Wire isolation	PVC (br, bl, bk)
Jacket Color	gray

Material (jacket)	PVC (UL/CSA)
Outer Ø	4.5 mm ±5%
Bend radius (moving)	10× outer Ø
Temperature range (fixed)	-30...+80 °C
Temperature range (mobile)	-5...+80 °C

Commercial data

country of origin	DE
customs tariff number	85444290
EAN	4048879120296
eClass	27279218
Packaging unit	1