

M23 SERVO CABLE

Specification: 6FX8002-5DS01-1AG5

Power cable with brake wires for SINAMICS S120 and motors with M23 connection and holding brake

Female straight – pre-wired terminals

M23, 6-pole
shielded

without cable sleeves

Further cable lengths on request.

Plastic housings with good resistance against chemicals and oils.

The resistance to aggressive media should be individually tested for your application. Further details on request.

[Link to Product](#)

Illustration

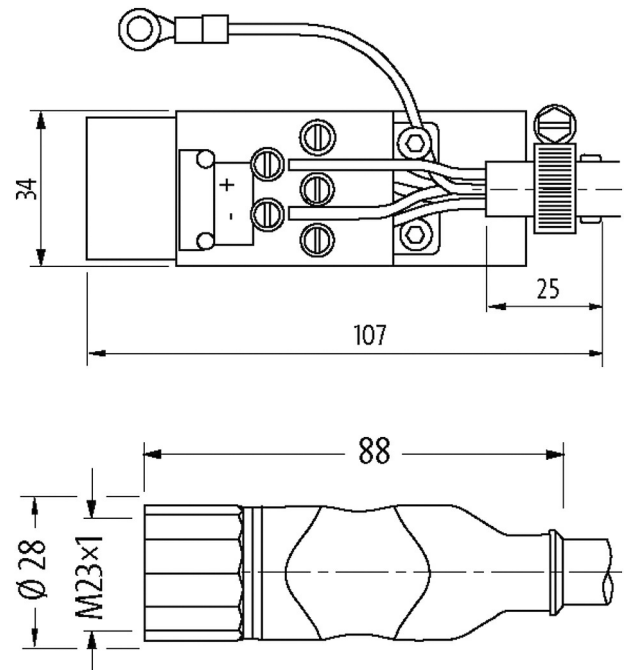

Product may differ from Image

Form

Form PS011

Technical Data

Operating voltage	600 V AC/DC (PIN 1/2/3/6); 250 V AC/DC (PIN 4/5)
Rated surge voltage	4 kV (PIN 1/2/3/6); 2 kV (PIN 4/5)
Operating current per contact	Power cores: 12 A (1.5 mm ²), 15 A (2.5 mm ²); brake cores: 5 A (1.5 mm ²)
Material group	IEC 60664-1, category I
Locking of ports	Screw thread (M23×1 mm) recommended torque 2.0 Nm, self-securing
Compression gland	M23 (SW27)
Protection	IP20/IP67
Locking material	Brass, nickel plated
Material	PUR
suitable for corrugated tube (internal Ø)	16 mm

General data

Pollution Degree	3
Temperature range	-25...+85 °C, depending on cable quality

Cables	
Cable number	821
No./diameter of wires	(4G1.5 + (2× 1.5)C)-C
Wire isolation	TPM (bk num, gnye)
C-track properties	10 Mio.
Torsion stress	±30°/m
Jacket Color	orange
Material (jacket)	PUR (UL/CSA) (=MC800+)
Specification	6FX8008-1BA11
Outer Ø	11.6 mm ±5%
Bend radius (fixed)	5× outer Ø
Bend radius (moving)	7.5× outer Ø
Temperature range (fixed)	-50...+80 °C
Temperature range (mobile)	-35...+70 °C
Shield	yes
Approval (cable)	cURus (AWM-Style 21223/10492)
Diameter (core)	4× 2.5 + 2× 1.5 mm ²
Commercial data	
country of origin	DE
customs tariff number	85444290
EAN	4048879603034
eClass	27279218
Packaging unit	1