

M12 male 90° B-cod. with cable shielded

PVC 1x2xAWG24 shielded vt UL/CSA 5m

PROFIBUS

Male 90°

M12, 2-pole

B-coded

shielded

Plastic housings with good resistance against chemicals and oils.

The resistance to aggressive media should be individually tested for your application. Further details on request.

Further cable lengths on request.

[Link to Product](#)

Illustration

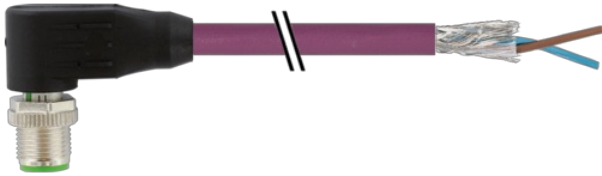

Male

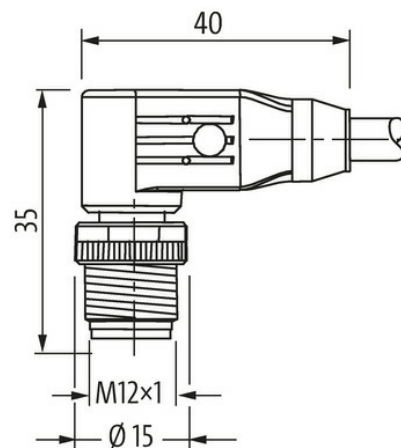
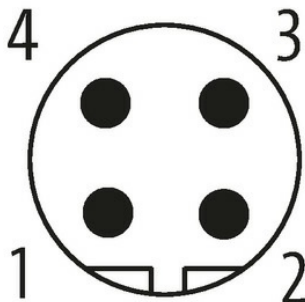

Product may differ from Image



* only for products with UL/CSA approved cable

Form	
Form	14081
Technical Data	
Operating voltage	max. 60 V AC/DC
Operating voltage (only UL listed)	max. 30 V AC/DC
Operating current per contact	max. 4 A
Locking of ports	Screw thread (M12×1 mm) recommended torque 0.6 Nm, self-securing
Protection	IP65, IP66K, IP67 inserted and tightened (EN 60529)
Locking material	Zinc die casting, matte nickel plated
General data	
Temperature range	-25...+85 °C, depending on cable quality
Cables	
No./diameter of wires	1 × 2 × 0.25 mm ²
Wire isolation	PE (rd, gn)
C-track properties	2 Mio.
Outer Ø	7.8 mm ±5%
Cable identification	850
Cable weight [g/m]	75,9 g
Material (wire)	Cu wire, bare
Resistor (core)	max. 68 Ω/km (20 °C)
Single wire Ø (core)	0.13 mm
Construction (core)	19 × 0.13 mm
Diameter (core)	1 × 2 × 0.25 mm ²
AWG	similar to AWG 24
Material (wire isolation)	PE
Wire-Ø incl. isolation	2.55 mm ±5%
Color/numbering of wires	rd, gn
Shield	yes
optical shield cover	min. 70%
Material (jacket)	PVC
Outer-Ø (jacket)	7.8 mm ±5%
Color (jacket)	violet
Jacket Color	violet
Nominal voltage	30 V AC
Test voltage	1.5 kV
Temperature range (fixed)	-25...+70 °C
Temperature range (fixed)	-25...+70 °C
Temperature range (mobile)	-20...+50 °C
Temperature range (mobile)	-20...+50 °C
Bend radius (fixed)	7.5 × outer Ø
Bend radius (moving)	12 × outer Ø
Bend radius (moving)	12 × outer Ø
No. of bending cycles (C-track)	max. 2 Mio. (25 °C)
Travel speed (C-track)	max. 3 m/s
Acceleration (C-track)	max. 5 m/s ²
Material (jacket)	PVC (UL)
Commercial data	
country of origin	DE

customs tariff number	85444290
EAN	4048879471480
eClass	27061801
Packaging unit	1.000