

B6 Surface mounted h., high profile, IP65

Single locking lever m., 2 entries M25, p-cover

B6

Surface mounted housing (high)

Single locking lever

IP65

Technical data will be only guaranteed with Murrelektronik components.

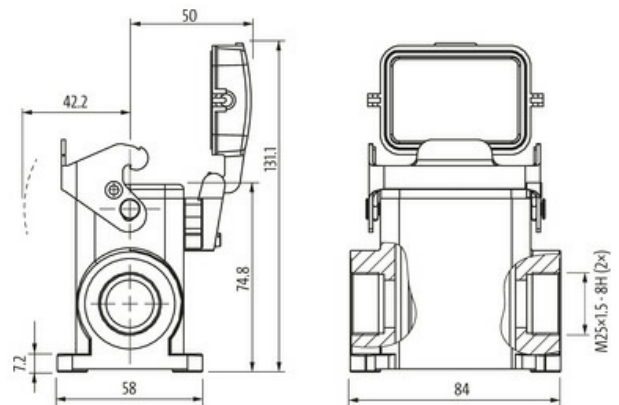
[Link to Product](#)**Illustration**

Product may differ from Image

Technical Data

Mating cycles	min. 500
Locking of ports	Single locking lever
Protection (housing)	IP65 inserted and tightened (EN 60529), with gland

General data

Material (gasket)	NBR
Temperature range	-40...+100 °C
Material (housing)	Aluminum die-cast
Housing type	Surface mounted housing
Threaded hole	M25
Size	B6
Cable outlet	double-sided
Protective cover	Plastic
Locking material	Steel (galvanized)
Climatic category	40/100/21 (EN 60068-1)
Material (housing surface)	powder-coated

Commercial data

country of origin	CZ
customs tariff number	85389099
EAN	4048879696333
eClass	27279221
Packaging unit	1.000