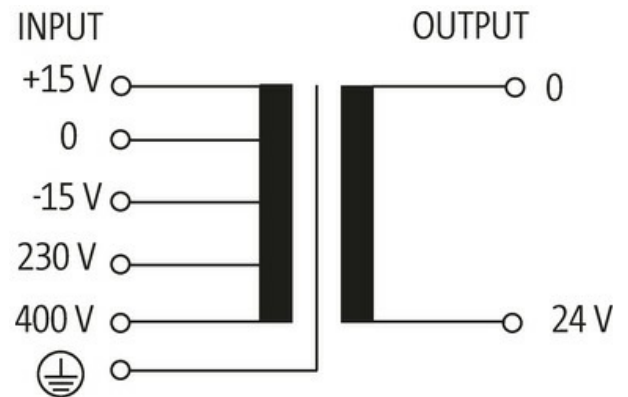

MTS 1-PHASE SAFETY TRANSFORMER

P: 100VA IN: 230/400VAC +/- 15VAC OUT: 24VAC

Single-phase safety transformer
100 VA
Isolation class T 40/B
Other voltages on request.

[Link to Product](#)**Illustration**

Product may differ from Image

**General data**

Standards	EN 61558-1, EN 61558-2-6, EN 62041 category 0
Mounting method	Long-hole mounting or DIN-rail mountable TH35 (EN 60715)
Temperature range	-20...+40 °C (storage temperature -40...+80 °C)
Test isolation voltage	4 kV (prim./sec.)
Drill hole Ø	4.8×8.4 mm
Fixing centers a×b×c	64.5×64×4.8 mm

The information in this brochure has been compiled with the utmost care.
Liability for the correctness completeness and topicality of the information is restricted to gross negligence. Version: 03/22

Dimensions H×W×D 86×84×98 mm

Output

Output voltage 24 V AC (SELV)

Output rating 100 VA

Input

Input voltage 230/400 ±15 V AC

Inrush current 4.1 A (230 V AC); 2.3 A (400 V AC)

Short-circuit current 6.6 A (230 V AC); 3.8 A (400 V AC)

Input current 0.5 A (230 V AC); 0.3 A (400 V AC)

Frequency 50...60 Hz

Commercial data

country of origin CZ

customs tariff number 85043180

EAN 4048879078436

eClass 27031302

Packaging unit 1.000