

M12 fem. recept. X-cod. / RJ45 male 0° shielded

PUR 4x2xAWG26 shielded gn UL/CSA 2m

Ethernet CAT6A

The resistance to aggressive media should be individually tested for your application. Further details on request.

Flange female straight – male straight

RJ45 – M12, 8-pole

X-coded

shielded

Rear mounting

Transmission properties with channel transmission up to 50 m

Further cable lengths on request.

Plastic housings with good resistance against chemicals and oils.

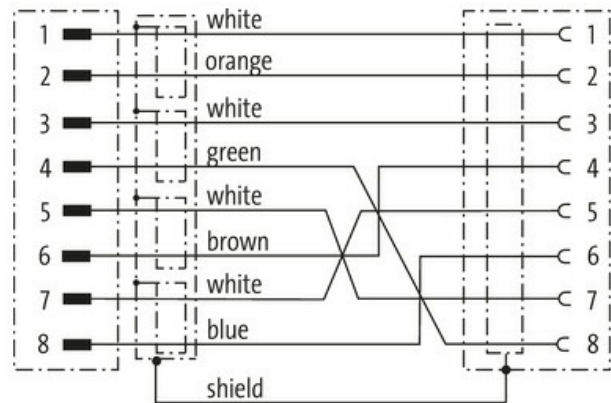
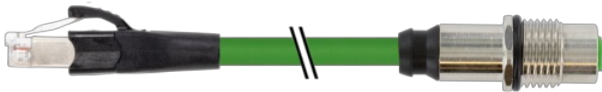
[Link to Product](#)**Illustration**

Male



Female

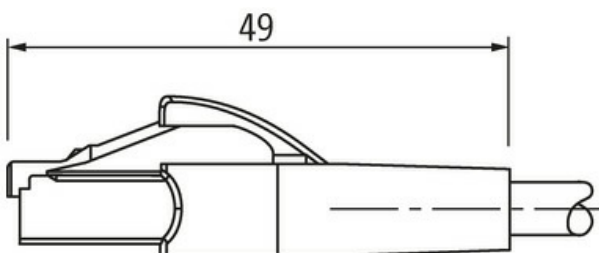
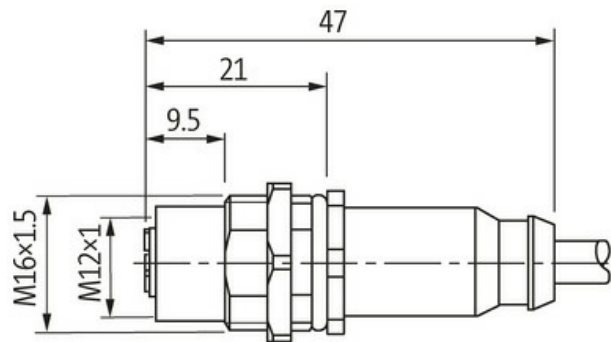
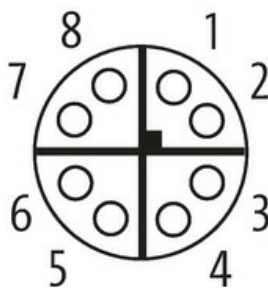

Product may differ from Image



* only for products with UL/CSA approved cable

Form	
Form	51551
Technical Data	
Operating voltage	max. 60 V DC
Operating voltage (only UL listed)	30 V DC
Rated surge voltage	0.8 kV
Operating current per contact	max. 0.5 A
No. of poles	8
Transfer parameters	CAT6, Class EA (ISO/IEC 11801:2002), (EN 50173-1)
Transfer rate	10 Gbit/s
Material group	IEC 60664-1, category I
Coding	M12, X-coded
LED display	no
Locking of ports	Screw thread (M12×1 mm) recommended torque 0.6 Nm, self-securing
Compression gland	M12 (SW14)
Protection	IP67 (M12) - IP20 (RJ45)
Protection NEMA	3, 4, 6P (UL 50E) (M12)
Material	PUR
Locking material	Brass, nickel plated
suitable for corrugated tube (internal Ø)	without
General data	
Standards	DIN EN 61076-2-109 (M12)
Mounting method	inserted, tightened
Pollution Degree	3
Temperature range	-25...+85 °C, depending on cable quality
Cables	
Cable identification	790
Approval (cable)	cURus (AWM-Style 20549/11635); CE conform
Cable weight [g/m]	52,8 g
Material (wire)	Cu wire, bare
Resistor (core)	max. 143 Ω/km (20 °C)
Single wire Ø (core)	0.16 mm
Diameter (core)	4× 2× AWG26/7
Material (wire isolation)	PE
Wire-Ø incl. isolation	1.05 mm ±5%
Color/numbering of wires	(WH, OR), (WH, BU), (WH, BN), (WH, GN)
Shield	yes
optical shield cover	approx. 65%
Material (jacket)	PUR
Outer-Ø (jacket)	6.4 mm ±5%
Color (jacket)	green
chemical resistance	Oil resistance according to IEC 60811-2-1, ASTM IRM 901, ICEA S-82-552 Std.
Nominal voltage	125 V AC
Test voltage	1500 V (wire/wire); 1000 V (wire/shield)
Temperature range (fixed)	-40...+80 °C
Temperature range (mobile)	-30...+70 °C
Bend radius (fixed)	8× outer Ø
Bend radius (moving)	10× outer Ø

The information in this brochure has been compiled with the utmost care.

Liability for the correctness completeness and topicality of the information is restricted to gross negligence. Version: 03/22

Commercial data

country of origin	DE
customs tariff number	85444290
EAN	4048879767705
eClass	27279220
Packaging unit	1.000