

**7/8" male 90° / 7/8" female 90°**

PUR 5x1.0 gy 1m

Male 90° – female 90°

7/8" – 7/8", 5-pole

Power cable

Further cable lengths on request.

Plastic housings with good resistance against chemicals and oils.

The resistance to aggressive media should be individually tested for your application. Further details on request.

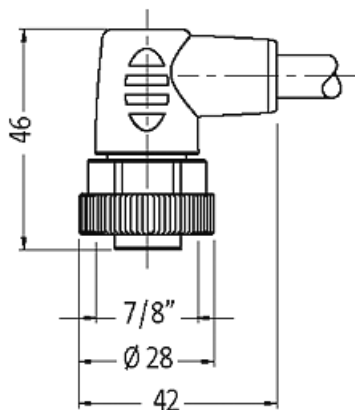
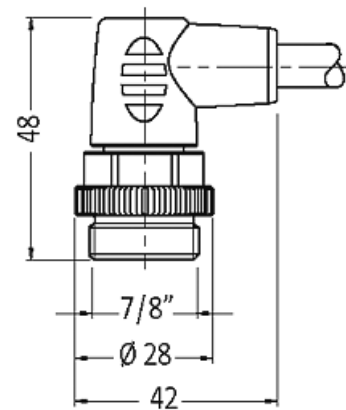
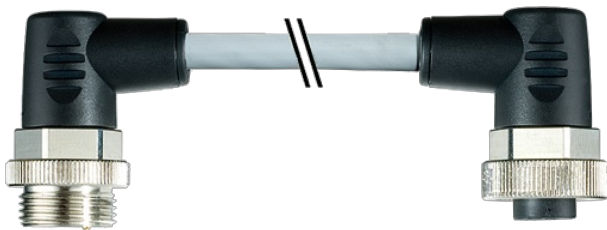
**Link to Product****Illustration**

1	black (1)	C 1
2	blue (2)	C 2
4	brown (3)	C 4
3	green / yellow (PE)	C 3
5	white (4)	C 5

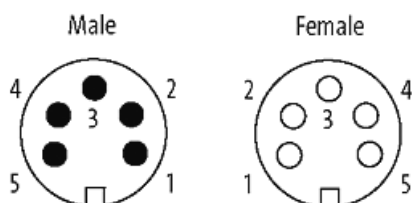

Product may differ from Image

**Form**

Form 50051

**Technical Data**

Operating voltage max. 230/400 V AC/DC

Rated surge voltage	3.0 kV
Operating current per contact	max. 12 A
Locking of ports	Screw thread 7/8" (recommended torque 1.5 Nm) self-securing
Protection	IP67 inserted and tightened (EN 60529)

**General data**

Temperature range	-25...+85 °C, depending on cable quality
-------------------	--

**Cables**

Cable number	965
No./diameter of wires	5× 1.0 mm <sup>2</sup>
Wire isolation	PP (br, wh, bl, bk num, gnye)
Jacket Color	gray
Material (jacket)	PUR/PVC
Outer Ø	7.2 mm ±5%
Bend radius (moving)	10× outer Ø
Temperature range (fixed)	-30...+70 °C
Temperature range (mobile)	-5...+70 °C
Cable identification	965
Approval (cable)	CE
Cable weight [g/m]	86,90
Material (wire)	Cu wire, bare
Resistor (core)	max. 19,5 Ω/km (20 °C)
Single wire Ø (core)	0.2 mm
Diameter (core)	5× 1.0 mm <sup>2</sup>
AWG	similar to AWG 17
Material (wire isolation)	PP
Shore hardness (wire isolation)	60 ±5 D
Wire-Ø incl. isolation	2.0 mm ±5%
Color/numbering of wires	bl, bk, wh, br, num; gnye longitudinally striped
Stranding combination	5 wires twisted around central filler
Shield	no
Material (jacket)	PUR/PVC
Material property (jacket)	CFC-, halogen-, cadmium-, silicone- and lead-free, matt, low-adhesion, machine easy to process, abrasion-resistant, hydrolysis and microbial resistant
Shore hardness (jacket)	81 ±5 A / 90 ±5 A
Outer-Ø (jacket)	7.2 mm ±5%
Color (jacket)	gray
Nominal voltage	600 V AC
Test voltage	3000 V AC
Current load capacity	to DIN VDE 0298-4
Temperature range (fixed)	-30...+70 °C
Temperature range (mobile)	-5...+70 °C
Bend radius (fixed)	7.5× outer Ø
Bend radius (moving)	10× outer Ø

**Commercial data**

country of origin	CZ
customs tariff number	85444290
EAN	4048879138161
eClass	27279218
Packaging unit	1