

PRE-WIRED CAP FOR EXACT8, 6XM8, 3 POLE

5.0m PUR 6x0,34+2x0,75, UL/CSA

for 6-way distribution box, 3-pole

Further cable lengths on request.

Plastic housings with good resistance against chemicals and oils.

The resistance to aggressive media should be individually tested for your application. Further details on request.

5.0 m

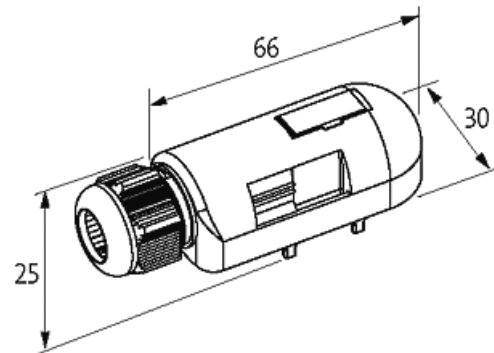
Link to Product**Illustration**

M8-Females 3-pole

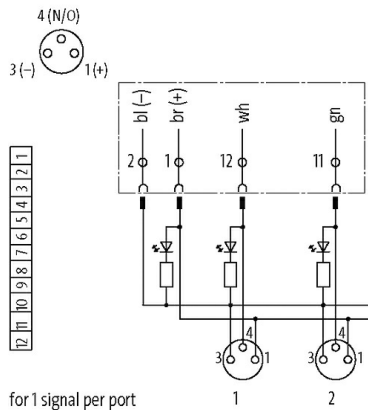

Product may differ from Image

**Technical Data**

Housing	Plastic, flame retardant
Total current	max. 8 A

General data

Temperature range	-20...+80 °C, depending on cable quality
-------------------	--

Cables

Cable number	356
No./diameter of wires	6 x 0.34 + 2 x 0.75 mm ²

Wire isolation	TPE (ye, wh, gn, gr, pk, rd+br, bl)
C-track properties	5 Mio.
Jacket Color	gray
Material (jacket)	PUR (UL/CSA)
Outer Ø	8.5 mm ±5%
Bend radius (fixed)	5× outer Ø
Bend radius (moving)	10× outer Ø
Temperature range (fixed)	-40...+80 °C
Temperature range (mobile)	-5...+60 °C
Color (jacket)	gray

Commercial data

country of origin	CZ
customs tariff number	85444290
EAN	4048879055055
eClass	27279219
Packaging unit	1