

M12 male 0° / M12 female 0° A-cod.

RADOX EM 104 4x0.34 shielded bk 3m

DeviceNet, CANopen
 Male straight – female straight
 M12 – M12, 5-pole
 shielded
 with cable sleeves

Plastic housings with good resistance against chemicals and oils.

The resistance to aggressive media should be individually tested for your application. Further details on request.
 Further cable lengths on request.

[Link to Product](#)

Illustration

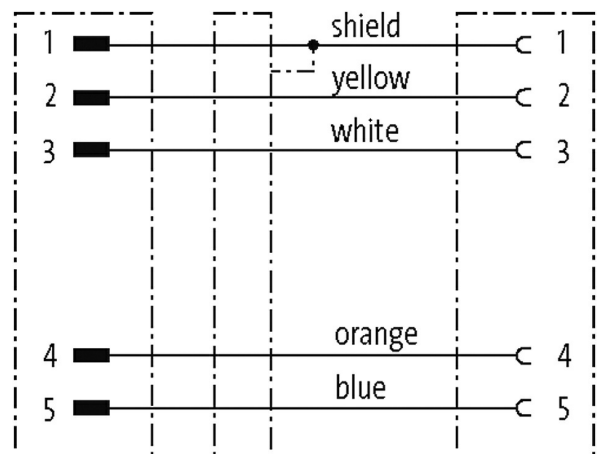
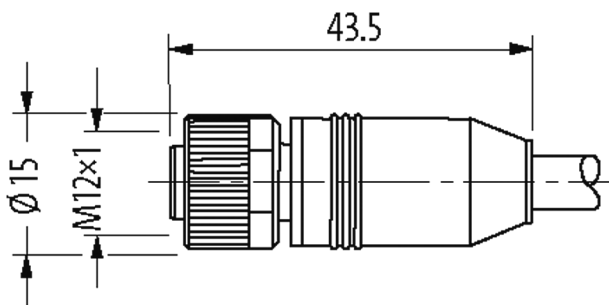
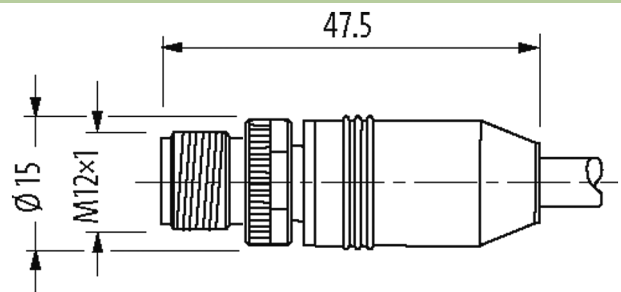

Male

Female

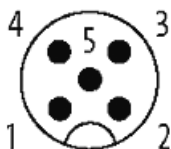

Product may differ from Image



Form	
Form	40531
Technical Data	
Operating voltage	max. 60 V AC/DC
Rated surge voltage	1.5 kV
Operating current per contact	max. 4 A
Material group	IEC 60664-1, category I
Coding	A-coded
Locking of ports	Screw thread (M12×1 mm) recommended torque 0.6 Nm, self-securing
Compression gland	M12 (SW13)
Locking material	Zinc die casting, matte nickel plated
Material	PUR
suitable for corrugated tube (internal Ø)	without
General data	
Standards	DIN EN 61076-2-101 (M12)
Mounting method	inserted, tightened
Pollution Degree	3
Temperature range	-25...+85 °C, depending on cable quality
Cables	
Cable identification	R66
Cable weight [g/m]	77,00
Material (wire)	Cu wire, tin plated
Resistor (core)	max. 55 Ω/km (20 °C)
Single wire Ø (core)	0.18 mm
Construction (core)	19× 0.18 mm
Diameter (core)	4× 0.34 mm ²
AWG	similar to AWG 22
Wire-Ø incl. isolation	1.55 mm ±5%
Color/numbering of wires	wh, ye, bl, or
Shield	yes
Material (jacket)	Radox EM 104
Outer-Ø (jacket)	6.6 mm ±5%
Color (jacket)	black
Nominal voltage	300 V AC
Test voltage	2000 V AC
Temperature range (fixed)	-50...+90 °C
Temperature range (mobile)	-40...+90 °C
Bend radius (fixed)	6× outer Ø
Bend radius (moving)	10× outer Ø
Commercial data	
country of origin	DE
customs tariff number	85444290
EAN	4048879672238
eClass	27061801
Packaging unit	1