

PRE-WIRED CAP FOR EXACT8, 10XM8, 3 POLE

5.0m PUR 10*0,34+2*0,75

for 10-way distribution box, 3-pole

Further cable lengths on request.

Plastic housings with good resistance against chemicals and oils.

The resistance to aggressive media should be individually tested for your application. Further details on request.

5.0 m

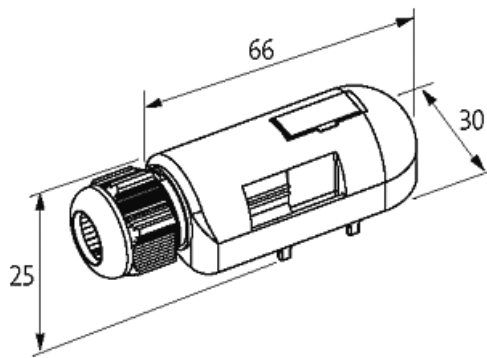
[Link to Product](#)**Illustration**

Product may differ from Image

M8-Females 3-pole

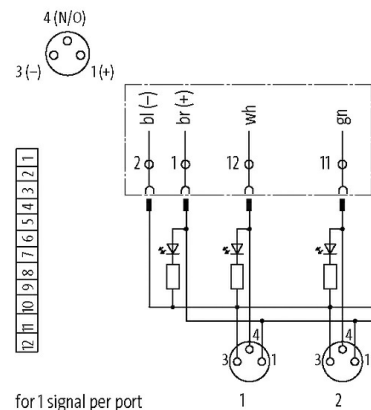
**Technical Data**

Total current	max. 8 A
Housing	Plastic, flame retardant

General data

Temperature range	-20...+80 °C, depending on cable quality
-------------------	--

Cables

Cable number	384
No./diameter of wires	10× 0.34 + 2× 0.75 mm ²

C-track properties	5 Mio.
Jacket Color	gray
Material (jacket)	PUR (UL/CSA)
Outer Ø	9.3 mm ±5%
Bend radius (fixed)	5× outer Ø
Bend radius (moving)	10× outer Ø
Temperature range (fixed)	-40...+80 °C
Temperature range (mobile)	-5...+60 °C
Color (jacket)	gray
Approval (cable)	UL (AWM-Style 20233), CSA

Commercial data

country of origin	CZ
customs tariff number	85444290
EAN	4048879056809
eClass	27143423
Packaging unit	1