

MOSA MQ12 FEMALE 0° FIELD-WIREABLE (IDC)4-pol. 0.25...0.5mm²

Female straight
MQ12, 4-pole
IDC terminals
Connection cross section: 0.25...0.5 mm²

[Link to Product](#)**Illustration**

Female

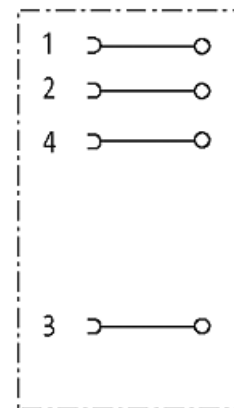
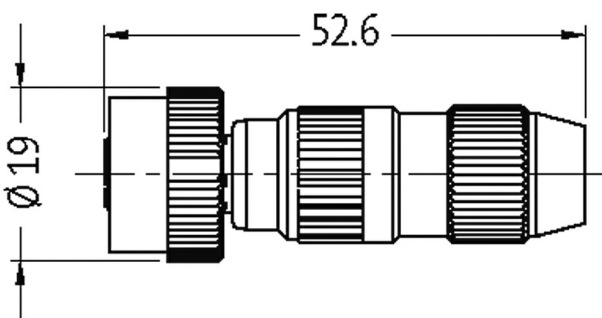
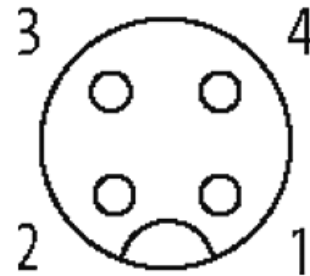

Product may differ from Image

Form

Form 12601

Technical Data

Operating voltage	max. 32 V AC/DC
Rated surge voltage	0.8 kV
Operating current per contact	max. 4 A
Material group	IEC 60664-1, category II
Connection cross section	0.25...0.5 mm ² (conductor diameter min. 0.1 mm)
Sealing range (cable Ø)	4...5.1 mm
Wire isolation	PVC, PP, TPE
Outer wire Ø	1.2...1.6 mm
Protection	IP67 inserted and tightened (EN 60529)

General data

Temperature range -25...+85 °C

Commercial data

country of origin	DE
customs tariff number	85366990
EAN	4048879106610
eClass	27279218
Packaging unit	1