

**M12 male 0° / M12 female 0° Y-cod. shielded**

PUR 0.20+0.38 shielded gn UL/CSA+drag ch. 3m

Male straight – female straight

M12 – M12, 8-pole

partly used

shielded

without cable sleeves

Ethernet CAT5

Plastic housings with good resistance against chemicals and oils.

The resistance to aggressive media should be individually tested for your application. Further details on request.

Further cable lengths on request.

[Link to Product](#)**Illustration**

Male

Female

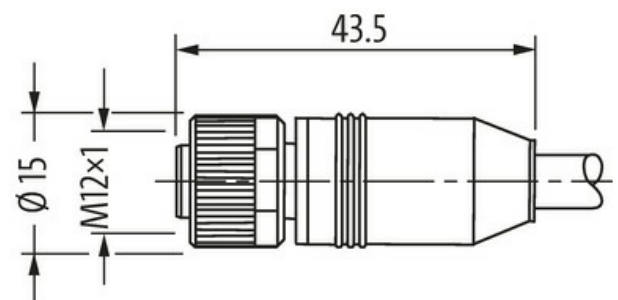
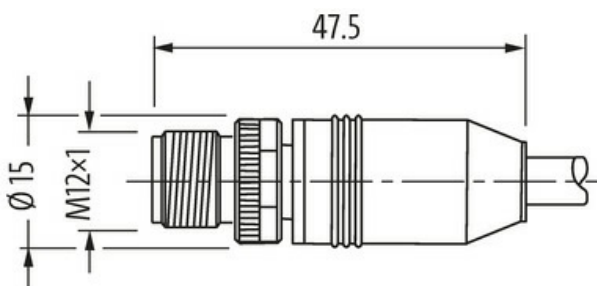
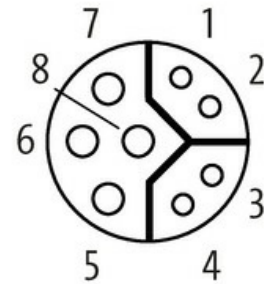
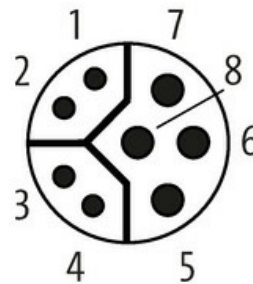

Product may differ from Image

EtherNet/IP

EtherCAT

**Form**

Form SS611

**Technical Data**

Operating voltage	max. 30 V AC/DC
Rated surge voltage	0.8 kV
Operating current per contact	0.5 A (Data), 6 A (Power)
Transfer parameters	CAT5, Class D (ISO/IEC 11801:2002), (EN 50173-1)
Transfer rate	up to 100 Mbit/s full duplex

The information in this brochure has been compiled with the utmost care.

Liability for the correctness completeness and topicality of the information is restricted to gross negligence. Version: 03/22

Murrelektronik Ltd. | 5 Albion Street, Pendlebury Industrial Estate, Swinton | Manchester M27 4FG | Fon +44 161 728 3133 | Fax +44 161 728 3130 | shop@murrelektronik.co.uk | shop.murrelektronik.co.uk

Material group	IEC 60664-1, category I
Coding	Y-coded
Locking of ports	Screw thread (M12×1 mm) recommended torque 0.6 Nm, self-securing
Compression gland	M12 (SW13)
Protection	IP67 inserted and tightened (EN 60529)
Material	PUR
Locking material	Zinc die casting, matte nickel plated
suitable for corrugated tube (internal Ø)	without

#### General data

Material (gasket)	FKM
Pollution Degree	3
Temperature range	-25...+85 °C, depending on cable quality

#### Cables

No./diameter of wires	2× 2× 0.20 + 1× 2× 0.38
Wire isolation	PO (gnye, pkbl, rdbk)
C-track properties	5 Mio.
Outer Ø	6.9 mm ±5%
Cable number	880
Shield	yes
optical shield cover	min. 85%
Material (jacket)	PUR
Jacket Color	green
Temperature range (fixed)	-20...+80 °C
Temperature range (mobile)	-20...+60 °C
Bend radius (moving)	10× outer Ø
Torsion stress	±30°/m
Material (jacket)	PUR (UL/CSA)

#### Commercial data

country of origin	DE
customs tariff number	85444290
EAN	4048879780612
eClass	27061801
Packaging unit	1.000