

**Mini (7/8) 3 pole, Male (Ext.) 90°/Female 90°**

TPE 3x16AWG ye UL/CSA, TC-ER

Male 90° – female 90°

7/8" – 7/8", 3-pole

Power cable

USA

Further cable lengths on request.

Plastic housings with good resistance against chemicals and oils.

The resistance to aggressive media should be individually tested for your application. Further details on request.

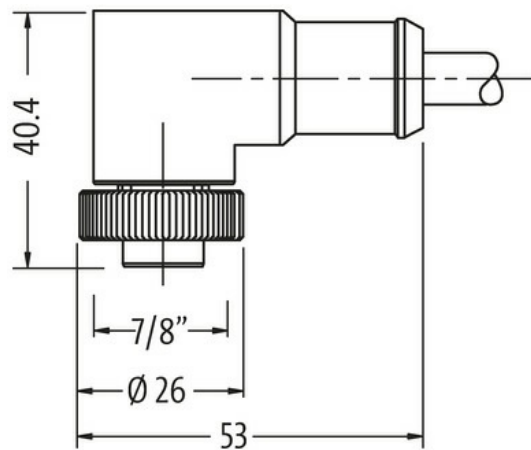
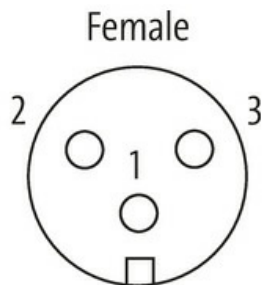
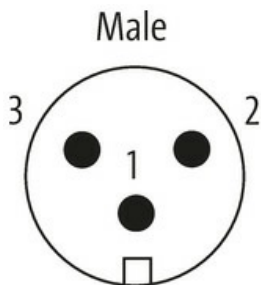
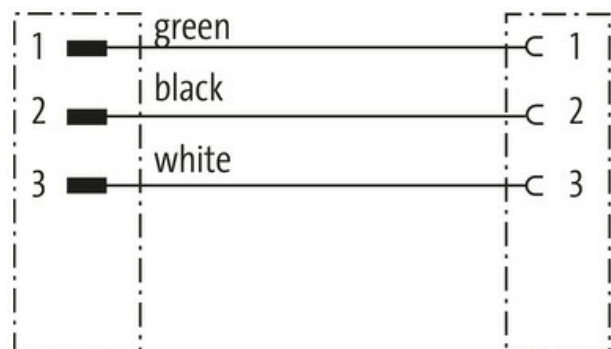
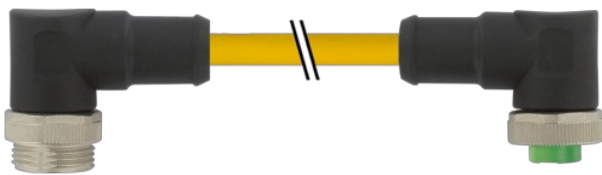
**[Link to Product](#)****Illustration**



Product may differ from Image



\* only for products with UL/CSA approved cable

**Form**

Form A3A31

**Technical Data**

Operating voltage	max. 600 V AC/DC
Operating current per contact	max. 12 A
Locking of ports	Screw thread 7/8" (recommended torque 1.5 Nm) self-securing
Compression gland	7/8" (SW24)
Protection	IP68 inserted and tightened (EN 60529)
Material	PUR
Locking material	Zinc die casting, matte nickel plated

**General data**

Temperature range -25...+80 °C, depending on cable quality

**Cables**

No./diameter of wires	3x 1.5 mm <sup>2</sup>
Wire isolation	PVC (bk, gn, wh)
Outer Ø	8.4 mm ±5%
Cable identification	U1B
Approval (cable)	UL (AWM-Style 21002/1841), CSA
Cable weight [g/m]	115,5 g
Material (wire)	Cu wire, bare
Resistor (core)	max. 13.2 Ω/km (20 °C)
Single wire Ø (core)	0.16 mm
Construction (core)	65x 0.16 mm (multi-strand wire class 6)
AWG	similar to AWG 16
Material (wire isolation)	PVC
Wire-Ø incl. isolation	2.6 mm ±5%
Color/numbering of wires	bk, gn, wh
Shield	no
Material (jacket)	TPE
Outer-Ø (jacket)	8.4 mm ±5%
Color (jacket)	yellow
Jacket Color	yellow
chemical resistance	good resistance to oil, gasoline and chemicals

The information in this brochure has been compiled with the utmost care.

Liability for the correctness completeness and topicality of the information is restricted to gross negligence. Version: 03/22

thermal resistance	flame retardant UL, FT4
Nominal voltage	600 V
Test voltage	6 kV spark test
Current load capacity	NEC (National Electric Code)
Temperature range (fixed)	-50...+105 °C
Temperature range (fixed)	-50...+105 °C
Temperature range (mobile)	-20...+90 °C
Temperature range (mobile)	-20...+90 °C
Bend radius (fixed)	8× outer Ø
Bend radius (moving)	10× outer Ø
Bend radius (moving)	10× outer Ø
Torsion stress	±90°/m
Material (jacket)	TPE (UL/CSA)

**Commercial data**

country of origin	DE
customs tariff number	85444290
EAN	4048879644754
eClass	27279218
Packaging unit	1.000