

M12 male 90° / M12 female 0° B-cod. shielded

PUR 1x2xAWG24 shielded vt UL/CSA+drag ch. 2m

PROFIBUS

Male 90° – female straight

M12 – M12, 2-pole

B-coded

shielded

Plastic housings with good resistance against chemicals and oils.

The resistance to aggressive media should be individually tested for your application. Further details on request.

Further cable lengths on request.

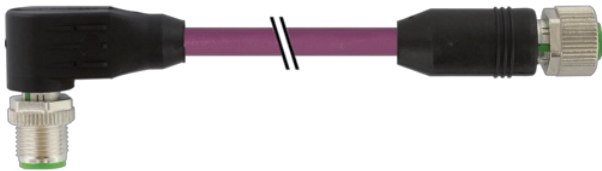
[Link to Product](#)**Illustration**

Male

Female

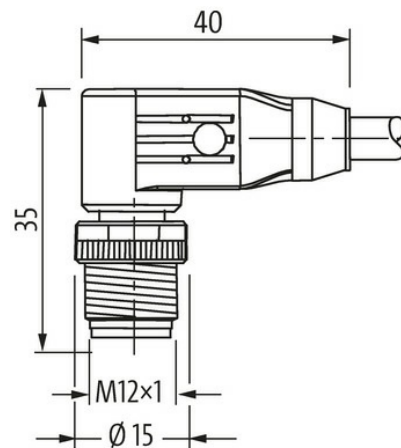
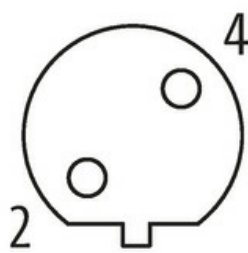



Product may differ from Image



* only for products with UL/CSA approved cable

Form

Form 44041

Technical Data

Operating voltage	max. 60 V AC/DC
Operating voltage (only UL listed)	max. 30 V AC/DC
Rated surge voltage	1.5 kV
Operating current per contact	max. 4 A
Locking of ports	Screw thread (M12×1 mm) recommended torque 0.6 Nm, self-securing
Protection	IP66K, IP67 inserted and tightened (EN 60529)
Locking material	Zinc die casting, matte nickel plated

Cables

Cable identification	840
Approval (cable)	cURus (AWM-Style 20549/10578), CE-conform
Cable weight [g/m]	82,5 g
Material (wire)	Cu wire, bare
Resistor (core)	max. 78 Ω/km (20 °C)
Single wire Ø (core)	0.127 mm
Construction (core)	19× 0.127 mm
AWG	similar to AWG 24
Wire-Ø incl. isolation	2.55 mm ±5%
Color/numbering of wires	rd, gn
Stranding combination	2 wires twisted
Shield	yes
optical shield cover	min. 70%
Material (jacket)	PUR
Outer-Ø (jacket)	7.8 mm ±5%
Color (jacket)	violet
chemical resistance	Oil resistance according to IEC 60811-2-1, ASTM IRM 901, ICEA S-82-552 Std.
Nominal voltage	250 V
Temperature range (fixed)	-40...+80 °C
Temperature range (mobile)	-20...+60 °C
Bend radius (fixed)	10× outer Ø
Bend radius (moving)	12× outer Ø
No. of bending cycles (C-track)	max. 5 Mio. (25 °C)
Travel speed (C-track)	max. 3 m/s
Acceleration (C-track)	max. 5 m/s ²

Commercial data

The information in this brochure has been compiled with the utmost care.
Liability for the correctness completeness and topicality of the information is restricted to gross negligence. Version: 03/22

country of origin	DE
customs tariff number	85444290
EAN	4048879345446
eClass	27061801
Packaging unit	1.000