

M12 female 0° Y-cod. with cable shielded

PUR AWG20/26 shielded gn UL/CSA+drag ch. 25m

Ethernet CAT5
 Female straight
 M12, 8-pole
 Y-coded
 shielded

Further cable lengths on request.

Plastic housings with good resistance against chemicals and oils.

The resistance to aggressive media should be individually tested for your application. Further details on request.

[Link to Product](#)

Illustration

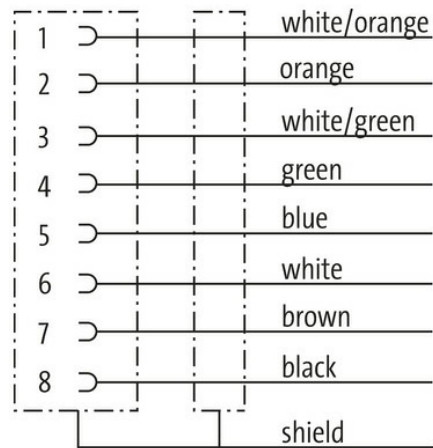
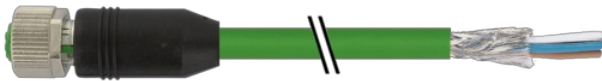

Female

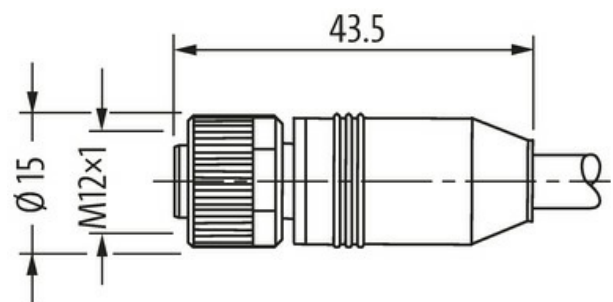
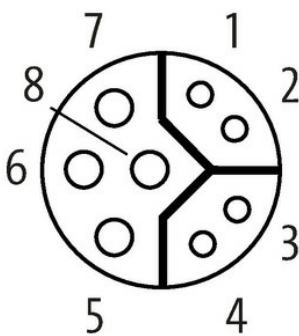

Product may differ from Image

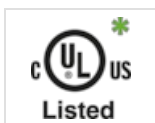

* only for products with UL/CSA approved cable

Form

Form 15551

Technical Data

Operating voltage	max. 50 V AC/DC
Operating voltage (only UL listed)	max. 30 V DC
Rated surge voltage	0.8 kV
Operating current per contact	0.5 A (Data), 6 A (Power)
Transfer parameters	CAT5, Class D (ISO/IEC 11801:2002), (EN 50173-1)
Transfer rate	up to 100 Mbit/s full duplex
Material group	IEC 60664-1, category I
Coding	Y-coded
Locking of ports	Screw thread (M12×1 mm) recommended torque 0.6 Nm, self-securing
Compression gland	M12 (SW13)
Protection	IP65 and IP67 when plugged and screwed down (EN 60529)
Material	PUR
Locking material	Zinc die casting, matte nickel plated
suitable for corrugated tube (internal Ø)	without

General data

Standards	DIN EN 61076-2-101 (M12)
Pollution Degree	3
Temperature range	-25...+85 °C, depending on cable quality

Cables

Cable identification	831
Approval (cable)	cURus (AWM-Style 20549/10493); CE conform
Cable weight [g/m]	107,8 g
Material (wire isolation)	PP
Material property (wire isolation)	CFC-, halogen-, cadmium-, silicone- and lead-free
Shore hardness (wire isolation)	55 ±5 D
Wire-Ø incl. isolation	1.5 mm ±5%
Color/numbering of wires	(bk, br, wh, bl), (whor, or, whgn, gn)
Shield	yes
optical shield cover	min. 85%
Material (jacket)	PUR
Material property (jacket)	CFC-, halogen-, cadmium-, silicone- and lead-free, matt, low-adhesion, machine easy to process, abrasion-resistant, hydrolysis and microbial resistant
Shore hardness (jacket)	90 ±5 A
Outer-Ø (jacket)	8.1 mm ±5%
Color (jacket)	green
chemical resistance	Oil resistance according to IEC 60811-2-1, ASTM IRM 901, ICEA S-82-552 Std.
thermal resistance	flame-retardant according to UL 1581 section 1090, section 1100 (FT2), IEC 60332-1-2 Std.
Nominal voltage	60 V AC
Test voltage	1000 V AC
Current load capacity	to DIN VDE 0298-4
Temperature range (fixed)	-40...+80 °C
Temperature range (mobile)	-30...+70 °C
Bend radius (fixed)	5× outer Ø
Bend radius (moving)	10× outer Ø
No. of bending cycles (C-track)	max. 2 Mio. (25 °C)
Travel speed (C-track)	max. 3.3 m/s
Acceleration (C-track)	max. 5 m/s ²
Torsion stress	±30°/m
No. of torsion cycles	max. 2 Mio. (25 °C)
Torsion speed	35 cycles/min

Commercial data

country of origin	DE
customs tariff number	85444290

EAN	4048879655293
eClass	27279218
Packaging unit	1.000