

**Valve plug MJC 0° with cable LED+VDR V2A**

PUR 2x0.5 bk drag ch. 10m

Xtreme - Outdoor

Female straight

12...24 V AC/DC

LED and VDR

Junior Timer

Plastic housings with good resistance against chemicals and oils.

The resistance to aggressive media should be individually tested for your application. Further details on request.

Further cable lengths on request.

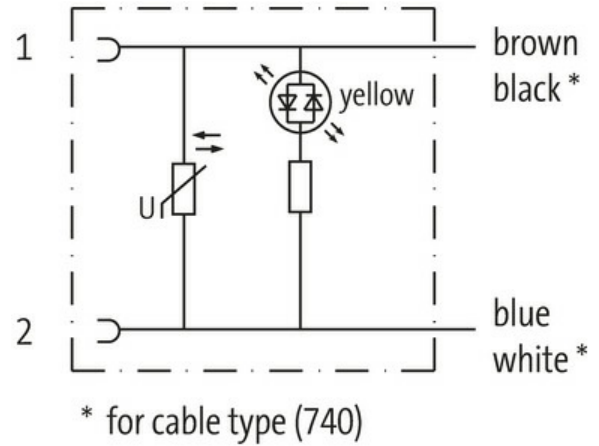
**[Link to Product](#)****Illustration**

Product may differ from Image

**Form**

Form 70061

**Technical Data**

Operating voltage 12...24 V AC/DC

Operating current per contact max. 4 A

Current consumption approx. 12 mA

LED display	(yellow)
Protection	IP65 inserted and tightened (EN 60529)
Material	PUR
Locking material	Stainless steel 1.4305 (V2A)
Housing	Black plastic, flame retardant

**General data**

Temperature range	-25...+85 °C, depending on cable quality
-------------------	--

**Cables**

No./diameter of wires	2× 0.5 mm <sup>2</sup>
Wire isolation	TPE (bk, wh)
C-track properties	2 Mio.
Outer Ø	5.0 mm ±5%
Cable identification	740
Approval (cable)	CE conform
Cable weight [g/m]	36,3 g
Material (wire)	Cu wire, bare
Resistor (core)	max. 39 Ω/km (20 °C)
Single wire Ø (core)	0.1 mm
Construction (core)	64× 0.1 mm (multi-strand wire class 6)
Diameter (core)	2× 0.5 mm <sup>2</sup>
AWG	similar to AWG 20
Material (wire isolation)	TPE-E
Wire-Ø incl. isolation	1.5 mm ±5%
Color/numbering of wires	bk, wh
Stranding combination	2 wires twisted
Shield	no
Material (jacket)	PUR
Outer-Ø (jacket)	5.0 mm ±5%
Color (jacket)	black
Jacket Color	black
Nominal voltage	300/500 V AC
Test voltage	2000 V AC
Temperature range (fixed)	-50...+90 °C
Temperature range (fixed)	-50...+90 °C
Temperature range (mobile)	-30...+90 °C
Temperature range (mobile)	-30...+90 °C
Bend radius (moving)	10× outer Ø
Bend radius (moving)	10× outer Ø
No. of bending cycles (C-track)	max. 2 Mio. (25 °C)
Travel speed (C-track)	max. 3.3 m/s
Acceleration (C-track)	max. 5 m/s <sup>2</sup>
Material (jacket)	PUR

**Commercial data**

country of origin	DE
customs tariff number	85444290
EAN	4048879311984
eClass	27279218
Packaging unit	1.000